



18



TIEMME

www.tiemme.com

COPYRIGHT

18

**VALVOLE PER
RADIATORI**

RADIATOR VALVES

Le valvole per riscaldamento Tiemme sono composte da corpo in ottone EN12165-CW617N nichelato o cromato con tenute in elastomero etilene-propilene (EPDM) e volantino di regolazione in ABS. Sono idonee per impieghi con temperatura massima di 110°C e pressione di esercizio massima di 10 bar.

Tiemme radiator valves are assembled with nickel-plated or chrome-plated EN12165-CW617N brass with ethylene-propylene rubber (EPDM) seals and ABS head. Such valves are suitable for maximum temperature 110°C and maximum working pressure 10 bar.

SCelta ADATTATORI/ADAPTORs SELECTION

(VEDI/SEE Pag. 264 - 265 - 266 - 267 - 268 - 270)

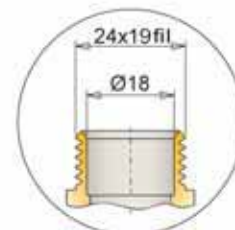
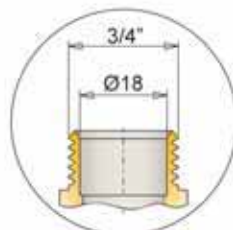
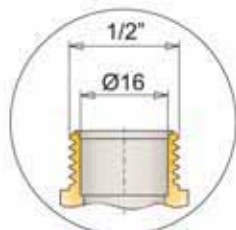
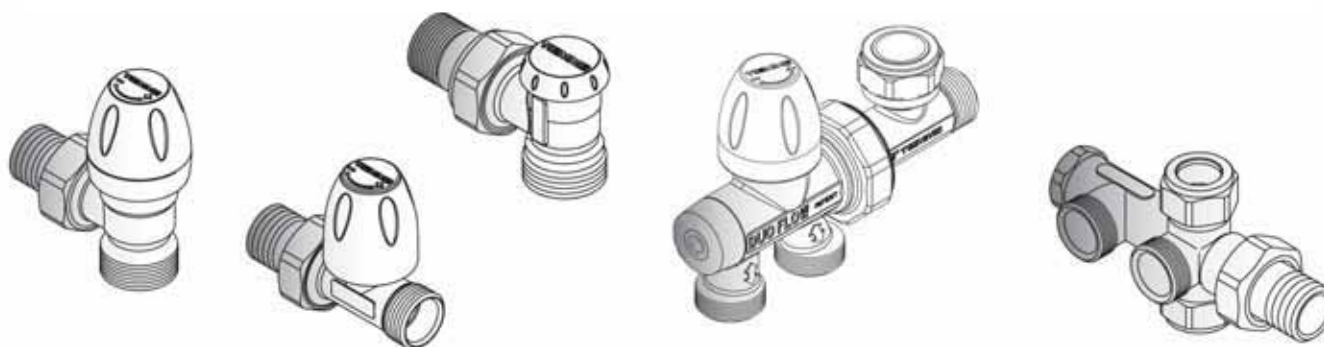

Art. 1668 (1/2")
per tubi multistrato
for multilayer pipe
Ø14x2,0
Ø16x2,0
Ø18x2,0
Ø20x2,0

Art. 1666
per tubi multistrato
for multilayer pipe
Ø14x2,0
Ø16x2,0
Ø18x2,0
Ø20x2,0

Art. 1666K
per tubi multistrato
for multilayer pipe
Ø16x2,0
Ø18x2,0
Ø20x2,0



Art. 1716
per tubi pe-x
for pe-x pipe
Ø16x1,8
Ø16x2,0
Ø20x1,9
Ø20x2,0

Art. 1716
per tubi pe-x
for pe-x pipe
Ø16x1,8
Ø16x2,0
Ø20x1,9
Ø20x2,0
Ø25x2,3

Art. 1716K
per tubi pe-x
for pe-x pipe
Ø16x1,8
Ø16x2,0
Ø20x1,9
Ø20x2,0



Art. 1635
per tubi multistrato
for multilayer pipe
Ø14x2,0
Ø16x2,0
Ø16x2,25

Art. 1636
per tubi multistrato
for multilayer pipe
Ø14x2,0 Ø16x2,0
Ø16x2,25 Ø17x2,0
Ø18x2,0 Ø20x2,0
Ø20x2,25 Ø20x2,5

Art. 1633K
per tubi multistrato
for multilayer pipe
Ø16x2,0
Ø18x2,0
Ø20x2,0



Art. 1435
per tubi pe-x
for pe-x pipe
Ø12x1,1 - Ø12x2,0
Ø14x2,0 - Ø15x2,5
Ø16x1,5 - Ø16x2,0
Ø16x2,2

Art. 1436
per tubi pe-x
for pe-x pipe
Ø12x2,0 - Ø14x2,0
Ø15x1,5 - Ø15x2,5
Ø16x1,5 - Ø16x2,0
Ø16x2,2 - Ø17x2,0
Ø18x2,0 - Ø18x2,5
Ø20x2,0 - Ø20x2,8

Art. 1433K
per tubi pe-x
for pe-x pipe
Ø15x2,5 - Ø16x2,0
Ø16x2,2 - Ø18x2,0
Ø18x2,5 - Ø20x2,8



Art. 1233 - 1235
per tubi in rame
for copper pipe
Ø10 - Ø12 - Ø14 - Ø16

Art. 1241
per tubi in rame
for copper pipe
Ø10 - Ø12 - Ø14
Ø15 - Ø16 - Ø18

Art. 1243K
per tubi in rame
for copper pipe
Ø15 - Ø16 - Ø18



Art. 1240
per tubi in rame
for copper pipe
Ø10 - Ø12 - Ø14
Ø15 - Ø16

VALVOLE TERMOSTATIZZABILI

THERMOSTATIC VALVES



ART. 3301

Valvola a squadra termostattizzabile con attacco per tubo rame /Pe-x/ multistrato
Angle valve with thermostatic option for copper/Pe-x/multilayer pipe

| CODICE Code | TIPO Size | ATTACCHI Connections | PREZZO Price € | CONF. Unit/Box |
|--------------------------------------|--------------|-------------------------|-------------------|-------------------|
| 330 0017 | G 3/8" | 1/2" - 16 | 9,64 | 10/60 |
| 330 0002 | G 1/2" | 1/2" - 16 | 10,04 | 10/60 |
| 330 0066 | G 3/8" | 3/4" - 18 | 16,29 | 10/60 |
| 330 0046 | G 1/2" | 3/4" - 18 | 15,82 | 10/60 |
| 330 0097 | G 1/2" | 24x19 fil (Ø18) | 12,37 | 10/60 |
| Versione con O-ring / O-ring version | | | | |
| 330 0011 | G 3/8" | 1/2" - 16 | 10,16 | 10/60 |
| 330 0003 | G 1/2" | 1/2" - 16 | 10,57 | 10/60 |
| 330 0071 | G 3/8" | 3/4" - 18 | 16,82 | 10/60 |
| 330 0051 | G 1/2" | 3/4" - 18 | 16,37 | 10/60 |
| 330 0108 | G 1/2" | 24x19 fil (Ø18) | 13,49 | 10/60 |

■ versione cromata / chrome-plated version



ART. 3300

Valvola diritta termostattizzabile con attacco per tubo rame /Pe-x/ multistrato
Straight valve with thermostatic option for copper/Pe-x/multilayer pipe

| CODICE Code | TIPO Size | ATTACCHI Connections | PREZZO Price € | CONF. Unit/Box |
|--------------------------------------|--------------|-------------------------|-------------------|-------------------|
| 330 0058 | G 3/8" | 1/2" - 16 | 11,50 | 10/60 |
| 330 0032 | G 1/2" | 1/2" - 16 | 11,91 | 10/60 |
| 330 0079 | G 3/8" | 3/4" - 18 | 13,33 | 10/60 |
| 330 0065 | G 1/2" | 3/4" - 18 | 13,56 | 10/60 |
| 330 0095 | G 1/2" | 24x19 fil (Ø18) | 14,65 | 10/60 |
| Versione con O-ring / O-ring version | | | | |
| 330 0048 | G 3/8" | 1/2" - 16 | 12,06 | 10/60 |
| 330 0036 | G 1/2" | 1/2" - 16 | 12,47 | 10/60 |
| 330 0082 | G 3/8" | 3/4" - 18 | 13,94 | 10/60 |
| 330 0083 | G 1/2" | 3/4" - 18 | 14,17 | 10/60 |
| 330 0109 | G 1/2" | 24x19 fil (Ø18) | 15,44 | 10/60 |

■ versione cromata / chrome-plated version



ART. 3306

Valvola a squadra termostattizzabile con attacco per tubo ferro
Angle valve with thermostatic option for iron pipe

| CODICE Code | TIPO Size | PREZZO Price € | CONF. Unit/Box |
|--------------------------------------|--------------|-------------------|-------------------|
| 330 0023 | G 3/8" | 11,25 | 10/60 |
| 330 0005 | G 1/2" | 11,64 | 10/60 |
| 330 0022 | G 3/4" | 18,60 | 10/60 |
| Versione con O-ring / O-ring version | | | |
| 330 0029 | G 3/8" | 11,78 | 10/60 |
| 330 0026 | G 1/2" | 12,17 | 10/60 |
| 330 0053 | G 3/4" | 19,14 | 10/60 |



ART. 3305

Valvola diritta termostattizzabile con attacco per tubo ferro
Straight valve with thermostatic option for iron pipe

| CODICE Code | TIPO Size | PREZZO Price € | CONF. Unit/Box |
|--------------------------------------|--------------|-------------------|-------------------|
| 330 0050 | G 3/8" | 12,47 | 10/60 |
| 330 0013 | G 1/2" | 13,32 | 10/60 |
| 330 0015 | G 3/4" | 21,18 | 10/60 |
| Versione con O-ring / O-ring version | | | |
| 330 0040 | G 3/8" | 13,04 | 10/60 |
| 330 0035 | G 1/2" | 13,87 | 10/60 |
| 330 0049 | G 3/4" | 21,73 | 10/60 |



ART. 3303

Valvola a squadra termostattizzabile con attacco per tubo rame /Pe-x/ multistrato. Versione con cappuccio di protezione
Angle valve with thermostatic option for copper/Pe-x/multilayer pipe with protection cap

| CODICE Code | TIPO Size | ATTACCHI Connections | PREZZO Price € | CONF. Unit/Box |
|--------------------------------------|--------------|-------------------------|-------------------|-------------------|
| 330 0019 | G 3/8" | 1/2" - 16 | 9,09 | 10/60 |
| 330 0006 | G 1/2" | 1/2" - 16 | 9,50 | 10/60 |
| 330 0067 | G 3/8" | 3/4" - 18 | 15,47 | 10/60 |
| 330 0038 | G 1/2" | 3/4" - 18 | 15,04 | 10/60 |
| Versione con O-ring / O-ring version | | | | |
| 330 0064 | G 3/8" | 1/2" - 16 | 9,64 | 10/60 |
| 330 0028 | G 1/2" | 1/2" - 16 | 10,04 | 10/60 |
| 330 0088 | G 3/8" | 3/4" - 18 | 15,98 | 10/60 |
| 330 0076 | G 1/2" | 3/4" - 18 | 15,55 | 10/60 |



ART. 3302

Valvola diritta termostattizzabile con attacco per tubo rame /Pe-x/ multistrato. Versione con cappuccio di protezione
Straight valve with thermostatic option for copper/Pe-x/multilayer pipe with protection cap

| CODICE Code | TIPO Size | ATTACCHI Connections | PREZZO Price € | CONF. Unit/Box |
|--------------------------------------|--------------|-------------------------|-------------------|-------------------|
| 330 0070 | G 3/8" | 1/2" - 16 | 10,93 | 10/60 |
| 330 0034 | G 1/2" | 1/2" - 16 | 11,36 | 10/60 |
| 330 0080 | G 3/8" | 3/4" - 18 | 12,73 | 10/60 |
| 330 0073 | G 1/2" | 3/4" - 18 | 12,95 | 10/60 |
| Versione con O-ring / O-ring version | | | | |
| 330 0078 | G 3/8" | 1/2" - 16 | 11,50 | 10/60 |
| 330 0068 | G 1/2" | 1/2" - 16 | 11,91 | 10/60 |
| 330 0087 | G 3/8" | 3/4" - 18 | 13,33 | 10/60 |
| 330 0081 | G 1/2" | 3/4" - 18 | 13,56 | 10/60 |

VALVOLE TERMOSTATIZZABILI

THERMOSTATIC VALVES



ART. 3308

Valvola a squadra termostattizzabile con attacco per tubo ferro. Versione con cappuccio di protezione
Angle valve with thermostatic option for iron pipe with protection cap

| CODICE Code | TIPO Size | PREZZO Price € | CONF. Unit/Box |
|--------------------------------------|--------------|-------------------|-------------------|
| 330 0031 | G 3/8" | 10,71 | 10/60 |
| 330 0001 | G 1/2" | 11,10 | 10/60 |
| 330 0027 | G 3/4" | 18,07 | 10/60 |
| Versione con O-ring / O-ring version | | | |
| 330 0057 | G 3/8" | 11,25 | 10/60 |
| 330 0055 | G 1/2" | 11,64 | 10/60 |
| 330 0075 | G 3/4" | 18,62 | 10/60 |



ART. 3307

Valvola diritta termostattizzabile con attacco per tubo ferro. Versione con cappuccio di protezione
Straight valve with thermostatic option for iron pipe with protection cap

| CODICE Code | TIPO Size | PREZZO Price € | CONF. Unit/Box |
|--------------------------------------|--------------|-------------------|-------------------|
| 330 0047 | G 3/8" | 11,91 | 10/60 |
| 330 0012 | G 1/2" | 12,75 | 10/60 |
| 330 0007 | G 3/4" | 20,61 | 10/60 |
| Versione con O-ring / O-ring version | | | |
| 330 0069 | G 3/8" | 12,47 | 10/60 |
| 330 0074 | G 1/2" | 13,32 | 10/60 |
| 330 0063 | G 3/4" | 21,19 | 10/60 |



ART. 3312

Valvola reversa termostattizzabile con attacco per tubo rame/Pe-x/multistrato. Versione con cappuccio di protezione
Reverse thermostatic valve with protection cap, for copper/pe-x/multilayer pipe

NEW

| CODICE Code | TIPO Size | ATTACCHI Connections | PREZZO Price € | CONF. Unit/Box |
|--------------------------------------|--------------|-------------------------|-------------------|-------------------|
| 331 0007 | G 1/2" | 3/4" - 18 | 19,57 | 10/60 |
| Versione con O-ring / O-ring version | | | | |
| 331 0008 | G 1/2" | 3/4" - 18 | 20,14 | 10/60 |



ART. 3313

Valvola reversa termostattizzabile con attacco per tubo ferro. Versione con cappuccio di protezione
Reverse thermostatic valve with protection cap, for iron pipe

NEW

| CODICE Code | TIPO Size | PREZZO Price € | CONF. Unit/Box |
|--------------------------------------|--------------|-------------------|-------------------|
| 331 0009 | G 1/2" | 19,57 | 10/60 |
| Versione con O-ring / O-ring version | | | |
| 331 0010 | G 1/2" | 20,14 | 10/60 |

DETTENTORI PER RADIATORI

LOCKSHIELDS FOR RADIATORS



ART. 3331

Detentore a squadra con attacco per tubo rame/Pe-x/multistrato
Angle lockshield for copper/Pe-x/multilayer pipe

| CODICE Code | TIPO Size | ATTACCHI Connections | PREZZO Price € | CONF. Unit/Box |
|--------------------------------------|--------------|-------------------------|-------------------|-------------------|
| 333 0007 | G 3/8" | 1/2" - 16 | 7,48 | 10/60 |
| 333 0002 | G 1/2" | 1/2" - 16 | 7,55 | 10/60 |
| 333 0033 | G 3/8" | 3/4" - 18 | 13,84 | 10/60 |
| 333 0013 | G 1/2" | 3/4" - 18 | 13,45 | 10/60 |
| 333 0043 | G 1/2" | 24x19 fil (Ø18) | 14,12 | 1/60 |
| Versione con O-ring / O-ring version | | | | |
| 333 0008 | G 3/8" | 1/2" - 16 | 8,11 | 10/60 |
| 333 0003 | G 1/2" | 1/2" - 16 | 8,19 | 10/60 |
| 333 0029 | G 3/8" | 3/4" - 18 | 14,30 | 10/60 |
| 333 0025 | G 1/2" | 3/4" - 18 | 13,91 | 10/60 |
| 333 0044 | G 1/2" | 24x19 fil (Ø18) | 14,61 | 1/60 |

■ versione cromata / chrome-plated version



ART. 3330

Detentore diritto con attacco per tubo rame/Pe-x/multistrato
Straight lockshield for copper/Pe-x/multilayer pipe

| CODICE Code | TIPO Size | ATTACCHI Connections | PREZZO Price € | CONF. Unit/Box |
|--------------------------------------|--------------|-------------------------|-------------------|-------------------|
| 333 0032 | G 3/8" | 1/2" - 16 | 8,49 | 10/60 |
| 333 0021 | G 1/2" | 1/2" - 16 | 8,58 | 10/60 |
| 333 0038 | G 3/8" | 3/4" - 18 | 9,90 | 10/60 |
| 333 0019 | G 1/2" | 3/4" - 18 | 9,90 | 10/60 |
| 333 0039 | G 1/2" | 24x19 fil (Ø18) | 10,40 | 1/60 |
| Versione con O-ring / O-ring version | | | | |
| 333 0030 | G 3/8" | 1/2" - 16 | 9,16 | 10/60 |
| 333 0023 | G 1/2" | 1/2" - 16 | 9,26 | 10/60 |
| 333 0041 | G 3/8" | 3/4" - 18 | 10,60 | 10/60 |
| 333 0028 | G 1/2" | 3/4" - 18 | 10,60 | 10/60 |
| 333 0040 | G 1/2" | 24x19 fil (Ø18) | 11,14 | 1/60 |

■ versione cromata / chrome-plated version

DETENTORI PER RADIATORI

LOCKSHIELDS FOR RADIATORS



ART. 3336

Detentore a squadra con attacco tubo ferro
Angle lockshield for iron pipe

| CODICE Code | TIPO Size | PREZZO Price € | CONF. Unit/Box |
|--------------------------------------|--------------|-------------------|-------------------|
| 333 0014 | G 3/8" | 8,56 | 10/60 |
| 333 0006 | G 1/2" | 8,19 | 10/60 |
| 333 0011 | G 3/4" | 19,34 | 10/60 |
| 333 0050 | G 1/2" | 8,60 | 1/60 |
| 333 0052 | G 3/4" | 20,31 | 1/60 |
| Versione con O-ring / O-ring version | | | |
| 333 0015 | G 3/8" | 9,06 | 10/60 |
| 333 0010 | G 1/2" | 8,84 | 10/60 |
| 333 0017 | G 3/4" | 19,96 | 10/60 |
| 333 0051 | G 1/2" | 9,28 | 1/60 |
| 333 0053 | G 3/4" | 20,96 | 1/60 |

■ versione cromata / chrome-plated version



ART. 3335

Detentore diritto con attacco per tubo ferro
Straight lockshield for iron pipe

| CODICE Code | TIPO Size | PREZZO Price € | CONF. Unit/Box |
|--------------------------------------|--------------|-------------------|-------------------|
| 333 0027 | G 3/8" | 9,39 | 10/60 |
| 333 0009 | G 1/2" | 9,16 | 10/60 |
| 333 0004 | G 3/4" | 21,32 | 10/60 |
| 333 0046 | G 1/2" | 9,63 | 1/60 |
| 333 0048 | G 3/4" | 22,37 | 1/60 |
| Versione con O-ring / O-ring version | | | |
| 333 0024 | G 3/8" | 10,11 | 10/60 |
| 333 0026 | G 1/2" | 9,85 | 10/60 |
| 333 0031 | G 3/4" | 21,99 | 10/60 |
| 333 0047 | G 1/2" | 10,34 | 1/60 |
| 333 0049 | G 3/4" | 23,08 | 1/60 |

■ versione cromata / chrome-plated version

VALVOLE PER TERMOARREDO

CHROME-PLATED RADIATOR VALVES



ART. 3301C

Valvola a squadra termostattizzabile con attacco per tubo rame/Pe-x/multistrato - Versione cromata lucida
Angle valve with thermostatic option for copper/Pe-x/multilayer pipe - Bright chrome-plated

| CODICE Code | TIPO Size | ATTACCHI Connections | PREZZO Price € | CONF. Unit/Box |
|----------------|--------------|-------------------------|-------------------|-------------------|
| 330 0042 | G 3/8" | 1/2" - 16 | 17,52 | 10/60 |
| 330 0009 | G 1/2" | 1/2" - 16 | 18,33 | 10/60 |



ART. 3300C

Valvola diretta termostattizzabile con attacco per tubo rame/Pe-x/multistrato - Versione cromata lucida
Straight valve with thermostatic option for copper/Pe-x/multilayer pipe - Bright chrome-plated

| CODICE Code | TIPO Size | ATTACCHI Connections | PREZZO Price € | CONF. Unit/Box |
|----------------|--------------|-------------------------|-------------------|-------------------|
| 330 0059 | G 3/8" | 1/2" - 16 | 21,45 | 10/60 |
| 330 0041 | G 1/2" | 1/2" - 16 | 22,43 | 10/60 |



ART. 3306C

Valvola a squadra termostattizzabile con attacco per tubo ferro - Versione cromata lucida
Angle valve with thermostatic option, for iron pipe. - Bright chrome-plated

| CODICE Code | TIPO Size | PREZZO Price € | CONF. Unit/Box |
|----------------|--------------|-------------------|-------------------|
| 330 0061 | G 3/8" | 19,68 | 10/60 |
| 330 0016 | G 1/2" | 21,96 | 10/60 |



ART. 3305C

Valvola diretta termostattizzabile con attacco per tubo ferro - Versione cromata lucida
Straight valve with thermostatic option for iron pipe - Bright chrome-plated

| CODICE Code | TIPO Size | PREZZO Price € | CONF. Unit/Box |
|----------------|--------------|-------------------|-------------------|
| 330 0060 | G 3/8" | 21,73 | 10/60 |
| 330 0025 | G 1/2" | 24,53 | 10/60 |



ART. 1240C

Per tubo rame/for copper pipe
Dado cromato + ogiva incorporata per attacco 1/2" x 16
Chrome-plated nut with brass and rubber rings for rif. 1/2" x 16

| CODICE Code | TIPO Size | PREZZO Price € | CONF. Unit/Box |
|----------------|--------------|-------------------|-------------------|
| 144 0084 | 10 x 1/2" | 3,79 | 10/400 |
| 144 0050 | 12 x 1/2" | 3,71 | 10/400 |
| 144 0067 | 14 x 1/2" | 3,67 | 10/400 |
| 144 0066 | 15 x 1/2" | 3,71 | 10/400 |
| 144 0081 | 16 x 1/2" | 4,05 | 10/400 |



ART. 1635C

Per tubo multistrato for multilayer pipe
Adattatore cromato per attacchi 1/2" x 16
Chrome-plated adapter for 1/2" x 16 connections

| CODICE Code | TIPO Size | PREZZO Price € | CONF. Unit/Box |
|----------------|-------------------|-------------------|-------------------|
| 144 0065 | 14 sp 2,0 x 1/2" | 4,27 | 10/350 |
| 144 0035 | 16 sp 2,0 x 1/2" | 3,92 | 10/300 |
| 144 0079 | 16 sp 2,25 x 1/2" | 4,31 | 10/300 |

DETENTORI PER TERMOARREDO

CHROME-PLATED PANEL LOCKSHIELDS



ART. 3331C

Detentore a squadra con attacco per tubo rame/Pe-x/multistrato - Versione cromata lucida
Angle lockshield for copper/Pe-x/multilayer pipe - Bright chrome-plated

| CODICE Code | TIPO Size | ATTACCHI Connections | PREZZO Price € | CONF. Unit/Box |
|----------------|--------------|-------------------------|-------------------|-------------------|
| 333 0016 | G 3/8" | 1/2" - 16 | 16,36 | 10/60 |
| 333 0005 | G 1/2" | 1/2" - 16 | 16,51 | 10/60 |



ART. 3330C

Detentore dritto con attacco per tubo rame/Pe-x/multistrato - Versione cromata lucida
Straight lockshield for copper/Pe-x/multilayer pipe - Bright chrome-plated

| CODICE Code | TIPO Size | ATTACCHI Connections | PREZZO Price € | CONF. Unit/Box |
|----------------|--------------|-------------------------|-------------------|-------------------|
| 333 0036 | G 3/8" | 1/2" - 16 | 17,14 | 10/60 |
| 333 0018 | G 1/2" | 1/2" - 16 | 17,29 | 10/60 |



ART. 3336C

Detentore a squadra con attacco per tubo ferro - Versione cromata lucida
Angle lockshield for iron pipe - Bright chrome-plated

| CODICE Code | TIPO Size | PREZZO Price € | CONF. Unit/Box |
|----------------|--------------|-------------------|-------------------|
| 333 0035 | G 3/8" | 18,42 | 10/60 |
| 333 0001 | G 1/2" | 18,42 | 10/60 |



ART. 3335C

Detentore dritto con attacco tubo ferro - Versione cromata lucida
Straight lockshield for iron pipe - Bright chrome-plated

| CODICE Code | TIPO Size | PREZZO Price € | CONF. Unit/Box |
|----------------|--------------|-------------------|-------------------|
| 333 0034 | G 3/8" | 19,29 | 10/60 |
| 333 0012 | G 1/2" | 19,29 | 10/60 |

COMANDI TERMOSTATICI

THERMOSTATIC CONTROLS

Testa
termostatica
Serie
Thermostatic head
Series



Heating
Controller



ART. 9557

Testa termostatica con elemento sensibile a liquido incorporato
Thermostatic head with liquid sensitive element

| CODICE Code | ATTACCO Connection | PREZZO Price € | CONF. Unit/Box |
|----------------|-----------------------|-------------------|-------------------|
| 955 0001 | M30 x 1,5 | 13,95 | 1/30 |



ART. 9557C

Testa termostatica con elemento sensibile a liquido incorporato cromata
Thermostatic head with liquid sensitive element chrome-plated

| CODICE Code | ATTACCO Connection | PREZZO Price € | CONF. Unit/Box |
|----------------|-----------------------|-------------------|-------------------|
| 955 0004 | M30 x 1,5 | 18,03 | 1/30 |



ART. 9557CA

Testa termostatica con elemento sensibile a liquido incorporato cromata/bianco
Thermostatic head with liquid sensitive element chrome-plated/white

| CODICE Code | ATTACCO Connection | PREZZO Price € | CONF. Unit/Box |
|----------------|-----------------------|-------------------|-------------------|
| 955 0002 | M30 x 1,5 | 17,63 | 1/30 |



ART. 9557CB

Testa termostatica con elemento sensibile a liquido incorporato bianco/cromata
Thermostatic head with liquid sensitive element white/chrome-plated

| CODICE Code | ATTACCO Connection | PREZZO Price € | CONF. Unit/Box |
|----------------|-----------------------|-------------------|-------------------|
| 955 0005 | M30 x 1,5 | 17,63 | 1/30 |



ART. 9558

Testa termostatica con elemento sensibile a liquido a distanza (lunghezza capillare 2 m)
Thermostatic head with distance liquid sensitive element (length 2 m)

| CODICE Code | ATTACCO Connection | PREZZO Price € | CONF. Unit/Box |
|----------------|-----------------------|-------------------|-------------------|
| 955 0003 | - | 52,84 | 1/1 |



ART. 9560

Anello antimanomissione per testa termostatica
Tamper-proof cap for thermostatic head

| CODICE Code | TIPO Size | PREZZO Price € | CONF. Unit/Box |
|----------------|----------------|-------------------|-------------------|
| 955 0006 | unica - single | 6,21 | 1/1 |

KIT VALVOLE TERMOSTATIZZABILI

KIT VALVES WITH THERMOSTATIC OPTION



ART. 3303KIT

Kit 3 pezzi composto da: valvola a squadra, testa termostatica e detentore con attacco per tubo rame / Pe-x / multistrato
 3-pieces kit composed of: angle valve, thermostatic head and lockshields for copper/Pe-x/multilayer pipe

| CODICE Code | TIPO Size | ATTACCHI Connections | PREZZO Price € | CONF. Unit/Box |
|----------------|--------------|-------------------------|-------------------|-------------------|
| 330 0010 | G 3/8" | 1/2" - 16 | 27,22 | 1/10 |
| 330 0004 | G 1/2" | 1/2" - 16 | 27,65 | 1/10 |
| 330 0077 | G 3/8" | 3/4" - 18 | 38,43 | 1/10 |
| 330 0030 | G 1/2" | 3/4" - 18 | 37,71 | 1/10 |



ART. 3302KIT

Kit 3 pezzi composto da: valvola diritta, testa termostatica e detentore con attacco per tubo rame / Pe-x / multistrato
 3-pieces kit composed of: straight valve, thermostatic head and lockshields for copper/Pe-x/multilayer pipe

| CODICE Code | TIPO Size | ATTACCHI Connections | PREZZO Price € | CONF. Unit/Box |
|----------------|--------------|-------------------------|-------------------|-------------------|
| 330 0056 | G 3/8" | 1/2" - 16 | 30,33 | 1/10 |
| 330 0039 | G 1/2" | 1/2" - 16 | 30,79 | 1/10 |
| 330 0090 | G 3/8" | 3/4" - 18 | 33,14 | 1/10 |
| 330 0054 | G 1/2" | 3/4" - 18 | 33,34 | 1/10 |



ART. 3308KIT

Kit 3 pezzi composto da: valvola a squadra, testa termostatica e detentore con attacco per tubo ferro
 3-pieces kit composed of: angle valve, thermostatic head and lockshields for iron pipe

| CODICE Code | TIPO Size | PREZZO Price € | CONF. Unit/Box |
|----------------|--------------|-------------------|-------------------|
| 330 0014 | G 3/8" | 29,59 | 1/10 |
| 330 0018 | G 1/2" | 29,62 | 1/10 |
| 330 0037 | G 3/4" | 45,56 | 1/10 |



ART. 3307KIT

Kit a 3 pezzi composto da: valvola diritta, testina termostatica e detentore diritto con attacco per tubo ferro
 3-pieces kit composed of: straight valve, thermostatic head and lockshield for iron pipe

| CODICE Code | TIPO Size | PREZZO Price € | CONF. Unit/Box |
|----------------|--------------|-------------------|-------------------|
| 330 0052 | G 3/8" | 32,00 | 1/10 |
| 330 0033 | G 1/2" | 32,53 | 1/10 |
| 330 0062 | G 3/4" | 50,14 | 1/10 |

VALVOLE MANUALI SERIE "MAXIMA" PER RADIATORI

"MAXIMA" MANUAL VALVES FOR RADIATOR



ART. 3321

Valvola a squadra manuale con attacco per tubo rame / Pe-x / multistrato.
 Versione cromata
 Manual valve for copper/Pe-x multilayer pipe.
 Chrome-plated version

| CODICE Code | TIPO Size | ATTACCHI Connections | PREZZO Price € | CONF. Unit/Box |
|--------------------------------------|--------------|-------------------------|-------------------|-------------------|
| 332 0002 | G 1/2" | 24x19 fil (Ø18) | 8,69 | 1/60 |
| Versione con O-ring / O-ring version | | | | |
| 332 0007 | G 1/2" | 24x19 fil (Ø18) | 9,48 | 1/60 |



ART. 3320

Valvola manuale diritta con attacco per tubo rame / Pe-x / multistrato.
 Versione cromata
 Straight manual valve for copper/Pe-x/multilayer pipe.
 Chrome-plated version

| CODICE Code | TIPO Size | ATTACCHI Connections | PREZZO Price € | CONF. Unit/Box |
|--------------------------------------|--------------|-------------------------|-------------------|-------------------|
| 332 0005 | G 1/2" | 24x19 fil (Ø18) | 9,10 | 1/60 |
| Versione con O-ring / O-ring version | | | | |
| 332 0013 | G 1/2" | 24x19 fil (Ø18) | 9,87 | 1/60 |



ART. 3326

Valvola a squadra manuale con attacco per tubo ferro.
 Versione cromata
 Manual valve for iron pipe.
 Chrome-plated version

| CODICE Code | TIPO Size | PREZZO Price € | CONF. Unit/Box |
|--------------------------------------|--------------|-------------------|-------------------|
| 332 0001 | G 1/2" | 8,43 | 1/60 |
| 332 0008 | G 3/4" | 13,04 | 1/60 |
| Versione con O-ring / O-ring version | | | |
| 332 0010 | G 1/2" | 9,13 | 1/60 |
| 332 0012 | G 3/4" | 13,62 | 1/60 |



ART. 3325

Valvola manuale diritta con attacco per tubo ferro.
 Versione cromata
 Straight manual valve for iron pipe.
 Chrome-plated version

| CODICE Code | TIPO Size | PREZZO Price € | CONF. Unit/Box |
|--------------------------------------|--------------|-------------------|-------------------|
| 332 0003 | G 1/2" | 8,82 | 1/60 |
| 332 0009 | G 3/4" | 13,53 | 1/60 |
| Versione con O-ring / O-ring version | | | |
| 332 0011 | G 1/2" | 9,53 | 1/60 |
| 332 0014 | G 3/4" | 14,11 | 1/60 |

VALVOLE MANUALI SERIE "EXCEL" PER RADIATORI

RADIATOR MANUAL VALVES "EXCEL" SERIES



ART. 3221EXCEL

Valvola manuale a squadra con attacco per tubo rame/Pe-x/ multistrato
Angle manual valve for copper/Pe-x/ multilayer pipe

| CODICE Code | TIPO Size | ATTACCHI Connections | PREZZO Price € | CONF. Unit/Box |
|--------------------------------------|--------------|-------------------------|-------------------|-------------------|
| 322 0004 | G 3/8" | 1/2" - 16 | 5,59 | 10/60 |
| 322 0002 | G 1/2" | 1/2" - 16 | 5,30 | 10/60 |
| 322 0006 | G 1/2" | 24x19 fil (Ø18) | 7,08 | 1/60 |
| Versione con O-ring / O-ring version | | | | |
| 322 0005 | G 3/8" | 1/2" - 16 | 6,26 | 10/60 |
| 322 0008 | G 1/2" | 1/2" - 16 | 6,19 | 10/60 |
| 322 0019 | G 1/2" | 24x19 fil (Ø18) | 7,82 | 1/60 |

■ versione cromata / chrome-plated version



ART. 3220EXCEL

Valvola manuale diritta con attacco per tubo rame/Pe-x/ multistrato
Straight manual valve for copper/Pe-x/ multilayer pipe

| CODICE Code | TIPO Size | ATTACCHI Connections | PREZZO Price € | CONF. Unit/Box |
|--------------------------------------|--------------|-------------------------|-------------------|-------------------|
| 322 0015 | G 3/8" | 1/2" - 16 | 6,17 | 10/60 |
| 322 0007 | G 1/2" | 1/2" - 16 | 6,44 | 10/60 |
| 322 0014 | G 1/2" | 24x19 fil (Ø18) | 7,45 | 1/60 |
| Versione con O-ring / O-ring version | | | | |
| 322 0018 | G 3/8" | 1/2" - 16 | 6,84 | 10/60 |
| 322 0011 | G 1/2" | 1/2" - 16 | 7,10 | 10/60 |
| 322 0023 | G 1/2" | 24x19 fil (Ø18) | 8,20 | 1/60 |

■ versione cromata / chrome-plated version



ART. 3226EXCEL

Valvola manuale a squadra con attacco per tubo ferro
Angle manual valve for iron pipe

| CODICE Code | TIPO Size | PREZZO Price € | CONF. Unit/Box |
|--------------------------------------|--------------|-------------------|-------------------|
| 322 0009 | G 3/8" | 6,49 | 10/60 |
| 322 0001 | G 1/2" | 5,70 | 10/60 |
| 322 0017 | G 3/4" | 11,97 | 10/60 |
| Versione con O-ring / O-ring version | | | |
| 322 0010 | G 1/2" | 6,84 | 10/60 |
| 322 0026 | G 3/4" | 12,54 | 10/60 |



ART. 3225EXCEL

Valvola manuale diritta con attacco per tubo ferro
Straight manual valve for iron pipe

| CODICE Code | TIPO Size | PREZZO Price € | CONF. Unit/Box |
|--------------------------------------|--------------|-------------------|-------------------|
| 322 0012 | G 3/8" | 6,67 | 10/60 |
| 322 0003 | G 1/2" | 6,67 | 10/60 |
| 322 0016 | G 3/4" | 14,01 | 10/60 |
| Versione con O-ring / O-ring version | | | |
| 322 0020 | G 1/2" | 7,33 | 10/60 |
| 322 0025 | G 3/4" | 14,59 | 10/60 |

DETENTORI SERIE "EXCEL" PER RADIATORI

LOCKSHIELDS RADIATORS "EXCEL" SERIES



ART. 3231EXCEL

Detentore a squadra con attacco per tubo rame/Pe-x/multistrato
Angle lockshield for copper/Pe-x/
multilayer pipe

| CODICE Code | TIPO Size | ATTACCHI Connections | PREZZO Price € | CONF. Unit/Box |
|--------------------------------------|--------------|-------------------------|-------------------|-------------------|
| 323 0004 | G 3/8" | 1/2" - 16 | 5,01 | 10/60 |
| 323 0002 | G 1/2" | 1/2" - 16 | 4,98 | 10/60 |
| 323 0017 | G 1/2" | 24x19 fil (Ø18) | 6,77 | 1/60 |
| Versione con O-ring / O-ring version | | | | |
| 323 0005 | G 3/8" | 1/2" - 16 | 5,74 | 10/60 |
| 323 0006 | G 1/2" | 1/2" - 16 | 6,00 | 10/60 |
| 323 0026 | G 1/2" | 24x19 fil (Ø18) | 7,60 | 1/60 |

■ versione cromata / chrome-plated version



ART. 3230EXCEL

Detentore diritto con attacco per tubo rame/Pe-x/multistrato
Straight lockshield for copper/Pe-x/
multilayer pipe

| CODICE Code | TIPO Size | ATTACCHI Connections | PREZZO Price € | CONF. Unit/Box |
|--------------------------------------|--------------|-------------------------|-------------------|-------------------|
| 323 0012 | G 3/8" | 1/2" - 16 | 5,51 | 10/60 |
| 323 0007 | G 1/2" | 1/2" - 16 | 5,93 | 10/60 |
| 323 0011 | G 1/2" | 24x19 fil (Ø18) | 7,14 | 1/60 |
| Versione con O-ring / O-ring version | | | | |
| 323 0015 | G 3/8" | 1/2" - 16 | 6,33 | 10/60 |
| 323 0019 | G 1/2" | 1/2" - 16 | 6,72 | 10/60 |
| 323 0024 | G 1/2" | 24x19 fil (Ø18) | 7,89 | 1/60 |

■ versione cromata / chrome-plated version



ART. 3236EXCEL

Detentore a squadra con attacco per tubo ferro
Angle lockshield for iron pipe

| CODICE Code | TIPO Size | PREZZO Price € | CONF. Unit/Box |
|--------------------------------------|--------------|-------------------|-------------------|
| 323 0009 | G 3/8" | 5,47 | 10/60 |
| 323 0001 | G 1/2" | 5,02 | 10/60 |
| 323 0013* | G 3/4" | 11,32 | 10/60 |
| Versione con O-ring / O-ring version | | | |
| 323 0008 | G 1/2" | 6,18 | 10/60 |
| 323 0023* | G 3/4" | 11,89 | 10/60 |

* Con cappuccio nichelato / with nickel-plated cap



ART. 3235EXCEL

Detentore diritto con attacco per tubo ferro
Straight lockshield for iron pipe

| CODICE Code | TIPO Size | PREZZO Price € | CONF. Unit/Box |
|--------------------------------------|--------------|-------------------|-------------------|
| 323 0010 | G 3/8" | 5,64 | 10/60 |
| 323 0003 | G 1/2" | 5,64 | 10/60 |
| 323 0014* | G 3/4" | 12,75 | 10/60 |
| Versione con O-ring / O-ring version | | | |
| 323 0016 | G 1/2" | 6,38 | 10/60 |
| 323 0018* | G 3/4" | 13,32 | 10/60 |

* Con cappuccio nichelato / with nickel-plated cap



ART. 3382K
Valvola manuale monotubo "DUOFLOW MAXIMA" ad ingresso acqua reversibile
Single pipe manual valve "DUOFLOW MAXIMA" with reversible flow inlet

| CODICE Code | TIPO Size | ATTACCHI Connections | PREZZO Price € | CONF. Unit/Box |
|----------------|--------------|-------------------------|-------------------|-------------------|
| 338 0001 | G 1/2" | 24x19 fil (Ø18) | 35,54 | 1/20 |

ART. 3382K

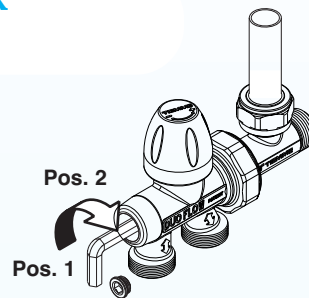

Ruotare di 180° in senso orario
Turn 180° clockwise

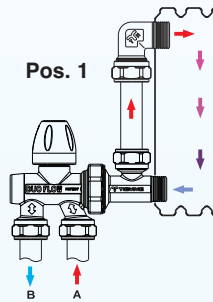

Collegamento standard
Standard connection

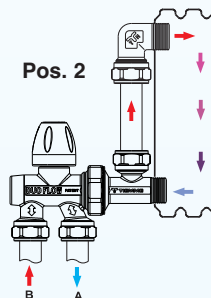

Collegamento con ingresso invertito
Reversed inlet connection



ART. 3385K
Valvola monotubo completa di sonda interna metallica (lunghezza 45 cm)
Single pipe valve with internal metallic probe (45 cm length)

| CODICE Code | TIPO Size | ATTACCHI Connections | PREZZO Price € | CONF. Unit/Box |
|----------------|--------------|-------------------------|-------------------|-------------------|
| 338 0003 | G 1/2" | 24x19 fil (Ø18) | 31,70 | 1/20 |



ART. 3383K
Valvola mono/bitubo "DUAL" ad ingresso acqua reversibile completa di sonda metallica Ø10 mm di lunghezza 45 cm
Single/double pipe valve "DUAL" with reversible flow inlet provided with Ø10 mm metallic probe 45 cm length

| CODICE Code | TIPO Size | ATTACCHI Connections | PREZZO Price € | CONF. Unit/Box |
|----------------|--------------|-------------------------|-------------------|-------------------|
| 338 0002 | G 1/2" | 24x19 fil (Ø18) | 31,70 | 1/20 |

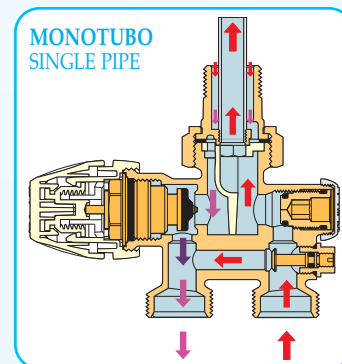
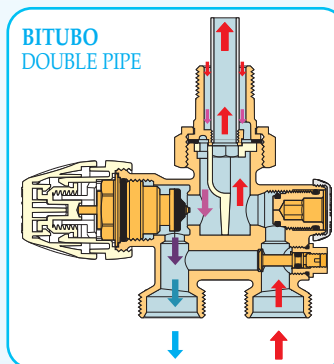

ART. 3382K - 3383K - 3385K

GUIDA ALLE CONNESSIONI CONNECTION GUIDE

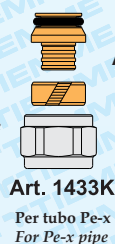
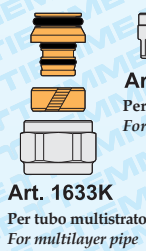
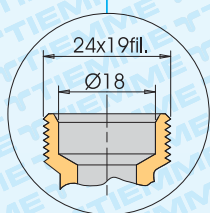
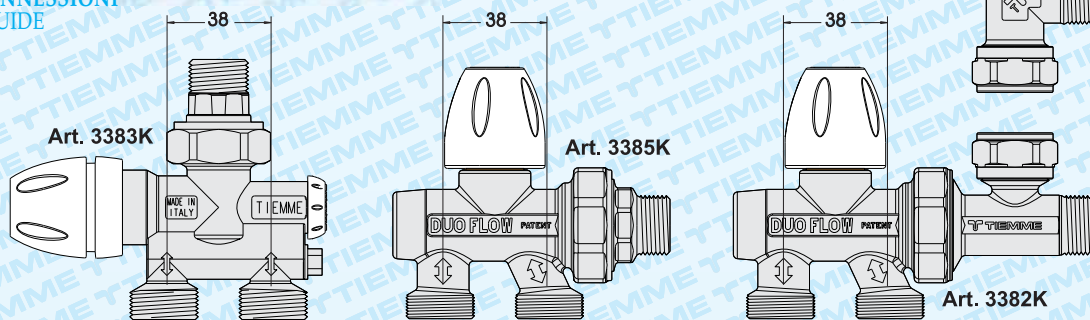

Per tabella giri di serraggio vedi pag 267-268 Cap. 17
For nut tightening table see pag 267-268 Chap. 17

VALVOLE E DISTRIBUTORI

SPECIAL VALVES



ART. 3370K

Distributore con attacchi per tubi dal pavimento con portata al radiatore 50% - Attacchi 24x19 fil (Ø18) con interasse 38 mm per tubi dal pavimento - Attacco per tubo rame Ø 15 al radiatore
 Distributor for pipes from the floor - Flow rate to the radiator 50% - Single pipe 24x19 tpi (Ø18) connection for floor pipes - Distance between centres 38 mm - Copper pipe connection Ø 15 to the radiator

| CODICE Code | TIPO Size | ATTACCHI Connections | PREZZO Price € | CONF. Unit/Box |
|----------------|--------------|-------------------------|-------------------|-------------------|
| 337 0003 | G 1/2" | 24x19 fil (Ø18) | 17,66 | 10/60 |



ART. 3375K

Distributore con attacchi per tubi dal pavimento con portata al radiatore 100% - Attacchi 24x19 fil (Ø18) con interasse 38 mm per tubi dal pavimento - Attacco per tubo rame Ø 15 al radiatore
 Distributor for pipes from the floor - Flow rate to the radiator 100% - Double pipe 24x19 tpi (Ø18) connection for floor pipes - Distance between centres 38 mm - Copper pipe connection Ø 15 to the radiator

| CODICE Code | TIPO Size | ATTACCHI Connections | PREZZO Price € | CONF. Unit/Box |
|----------------|--------------|-------------------------|-------------------|-------------------|
| 337 0002 | G 1/2" | 24x19 fil (Ø18) | 18,70 | 10/60 |



ART. 3371K

Distributore con attacchi per tubi dalla parete con portata al radiatore 50% - Attacchi 24x19 (18) con interasse 38 mm per tubi dalla parete - Attacco per tubo rame Ø 15 al radiatore
 Distributor for pipes from the wall - Flow rate to the radiator 50% - Single pipe 24x19 tpi (Ø18) connection for wall pipes - Distance between centres 38 mm - Copper pipe connection Ø 15 to the radiator

| CODICE Code | TIPO Size | ATTACCHI Connections | PREZZO Price € | CONF. Unit/Box |
|----------------|--------------|-------------------------|-------------------|-------------------|
| 337 0005 | G 1/2" | 24x19 fil (Ø18) | 27,20 | 10/60 |



ART. 3376K

Distributore con attacchi per tubi dalla parete con portata al radiatore 100% - Attacchi 24x19 (18) con interasse 38 mm per tubi dalla parete - Attacco per tubo rame Ø 15 al radiatore
 Distributor for pipes from the wall - Flow rate to the radiator 100% - Double pipe 24x19 tpi (Ø18) connection for wall pipes - Distance between centres 38 mm - Copper pipe connection Ø 15 to the radiator

| CODICE Code | TIPO Size | ATTACCHI Connections | PREZZO Price € | CONF. Unit/Box |
|----------------|--------------|-------------------------|-------------------|-------------------|
| 337 0006 | G 1/2" | 24x19 fil (Ø18) | 28,24 | 10/60 |

ART. 3370K - 3371K - 3375K - 3376K

GUIDA ALLE CONNESSIONI CONNECTION GUIDE

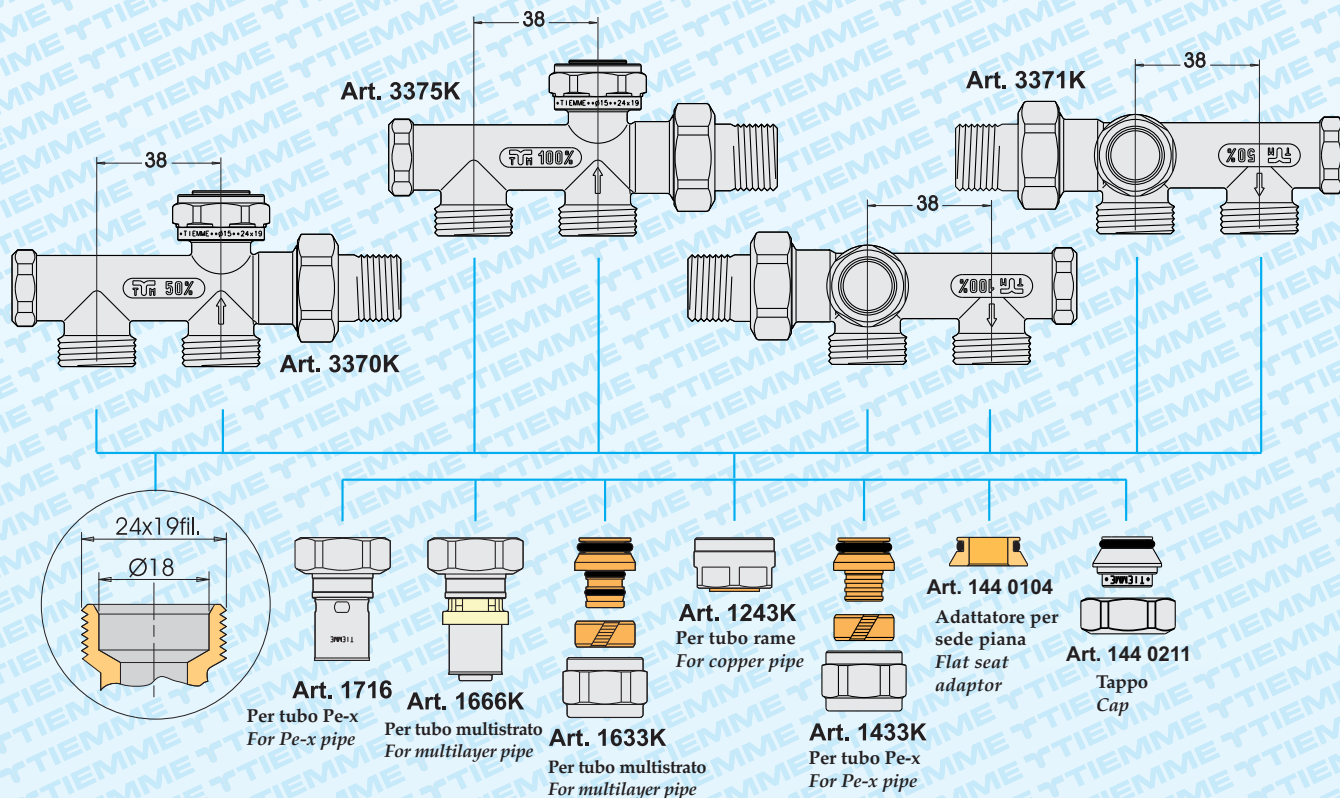

Per tabella giri di serraggio vedi pag 267-268 Cap. 17
 For nut tightenings table see pag 267-268 Chap. 17

VALVOLE E DISTRIBUTORI

SPECIAL VALVES



ART. 3361K

Valvola a squadra termostattizzabile con attacco tubo rame Ø 15
Angle valve, thermostatic option, copper pipe Ø 15 connection

| CODICE Code | TIPO Size | ATTACCHI Connections | PREZZO Price € | CONF. Unit/Box |
|----------------|--------------|-------------------------|-------------------|-------------------|
| 330 0045 | G 1/2" | 15 | 17,94 | 10/60 |

Fornibile anche nella versione con cappuccio di protezione da cantiere art. 330 0089 / Available also with protection cap art. 330 0089



ART. 3363K

Valvola a squadra termostattizzabile con attacco tubo rame Ø 15
Angle valve, thermostatic option, copper pipe Ø 15 connection

| CODICE Code | TIPO Size | ATTACCHI Connections | PREZZO Price € | CONF. Unit/Box |
|----------------|--------------|-------------------------|-------------------|-------------------|
| 330 0021 | G 1/2" | 15 | 17,06 | 10/60 |

Fornibile anche nella versione con cappuccio di protezione da cantiere art. 330 0020 / Available also with protection cap art. 330 0020

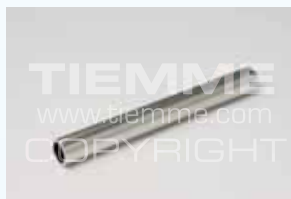

ART. 1505C

Tubetto cromato Ø 15
Chrome-plated Ø 15 tube

| CODICE Code | TIPO Size | PREZZO Price € | CONF. Unit/Box |
|----------------|--------------|-------------------|-------------------|
| 337 0008 | 60 cm | 3,03 | 10/500 |
| 337 0010 | 65 cm | 4,05 | 10/1000 |
| 337 0012 | 90 cm | 4,86 | 10/1000 |
| 337 0014 | 110 cm | 5,37 | 10/750 |

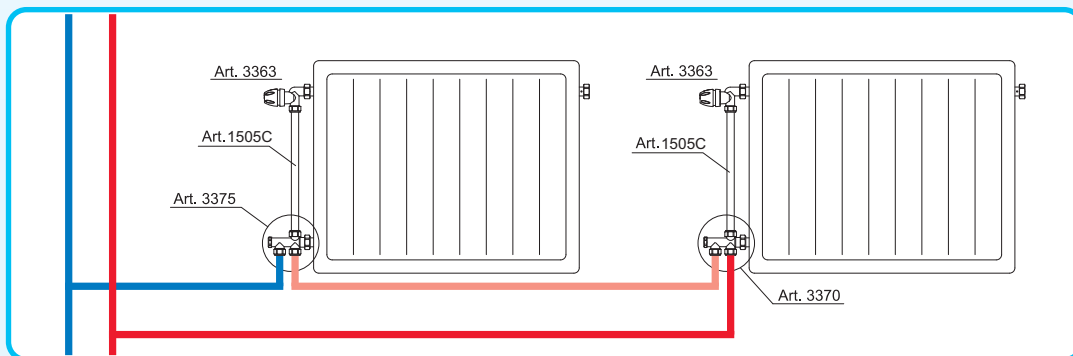
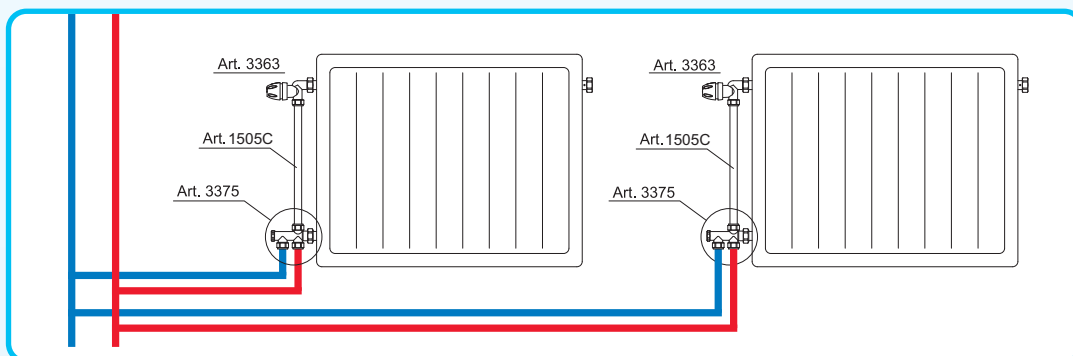

DISTRIBUTORI BITUBO

DOUBLE PIPES DISTRIBUTORS



ART. 3391

Distributore bitubo per piastre convettatrici con gruppo valvola termostatica incorporato. Attacchi per tubo da pavimento e raccordi per piastra da 3/4"x18 (Eurocono)
Straight valve 3/4" for two-pipe systems steel panel radiators with thermostatic valve group 3/4"x18 (Euroconus). Radiator connection



ART. 3393

Distributore bitubo per piastre convettatrici con gruppo valvola termostatica incorporato. Attacchi per tubo da parete e raccordi per piastra da 3/4"x18 (Eurocono)
Angle valve 3/4" for two-pipe systems steel panel radiators with thermostatic valve group 3/4"x18 (Euroconus). Radiator connection

| CODICE Code | TIPO Size | PREZZO Price € | CONF. Unit/Box |
|----------------|----------------------|-------------------|-------------------|
| 339 0001 | 3/4" Fem-3/4" Euroc. | 13,58 | 15/45 |
| 339 0010 | 3/4" Fem-24x19 fil | 16,59 | 15/45 |

| CODICE Code | TIPO Size | PREZZO Price € | CONF. Unit/Box |
|----------------|----------------------|-------------------|-------------------|
| 339 0002 | 3/4" Fem-3/4" Euroc. | 14,76 | 10/30 |
| 339 0004 | 3/4" Fem-24x19 fil | 16,59 | 10/30 |



ART. 3391BY

Distributore bitubo per piastre convettatrici con gruppo valvola termostatica incorporato e by-pass. Attacchi per tubo da pavimento e raccordi per piastra 3/4"x18 (Eurocono)
Straight valve with by-pass 3/4" for two-pipe systems steel panel radiators with thermostatic valve group 3/4"x18 (Euroconus). Radiator connection



ART. 3393BY

Distributore bitubo per piastre convettatrici con gruppo valvola termostatica incorporato e by-pass. Attacchi per tubo da parete e raccordi per piastra da 3/4"x18 Eurocono
Angle valve with by-pass 3/4" for two-pipe systems steel panel radiators with thermostatic valve group 3/4"x18 (Euroconus). Radiator connection

CON BY-PASS WITH BY-PASS

| CODICE Code | TIPO Size | PREZZO Price € | CONF. Unit/Box |
|----------------|----------------------|-------------------|-------------------|
| 339 0007 | 3/4" Fem-3/4" Euroc. | 21,68 | 15/45 |
| 339 0006 | 3/4" Fem-24x19 fil | 26,49 | 15/45 |

CON BY-PASS WITH BY-PASS

| CODICE Code | TIPO Size | PREZZO Price € | CONF. Unit/Box |
|----------------|----------------------|-------------------|-------------------|
| 339 0011 | 3/4" Fem-3/4" Euroc. | 23,58 | 10/30 |
| 339 0005 | 3/4" Fem-24x19 fil | 26,49 | 10/30 |



ART. 3390RID

Riduzione per attacchi 1/2" femmina
Adaptor for radiators with 1/2" female connections

| CODICE Code | TIPO Size | PREZZO Price € | CONF. Unit/Box |
|----------------|--------------|-------------------|-------------------|
| 339 0003 | 3/4" x 1/2" | 3,03 | 10/250 |

- versione nichelata / nickel-plated version
- versione cromata / chrome-plated version

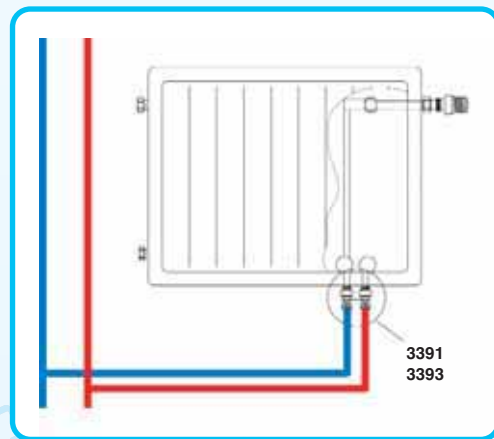

ART. 3391K-3393K

GUIDA ALLE CONNESSIONI CONNECTION GUIDE

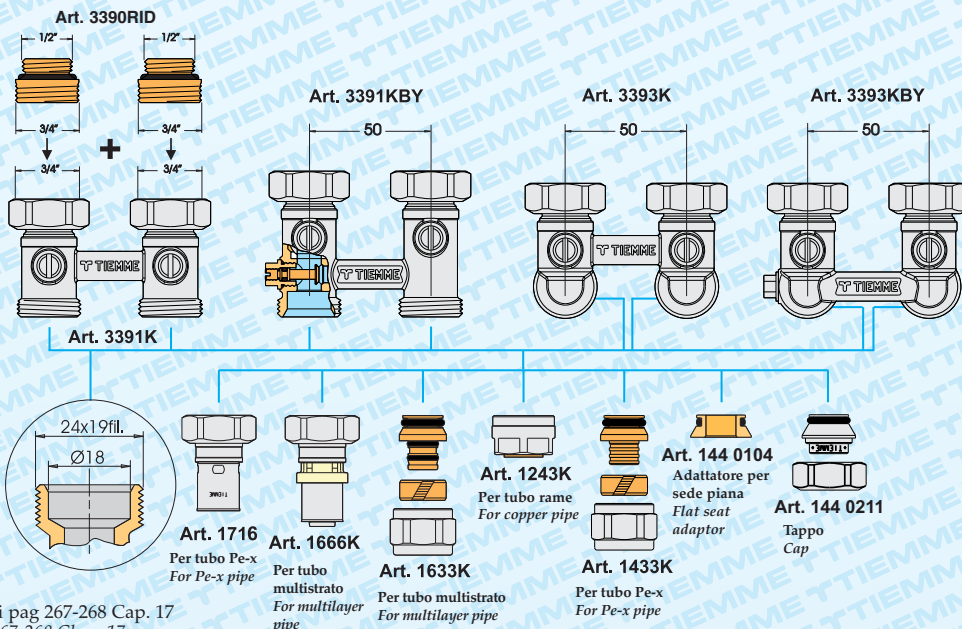

Per tabella giri di serraggio vedi pag 267-268 Cap. 17
 For nut tightenings table see pag 267-268 Chap. 17

ART. 3391N-3393N

GUIDA ALLE CONNESSIONI
FITTING GUIDE

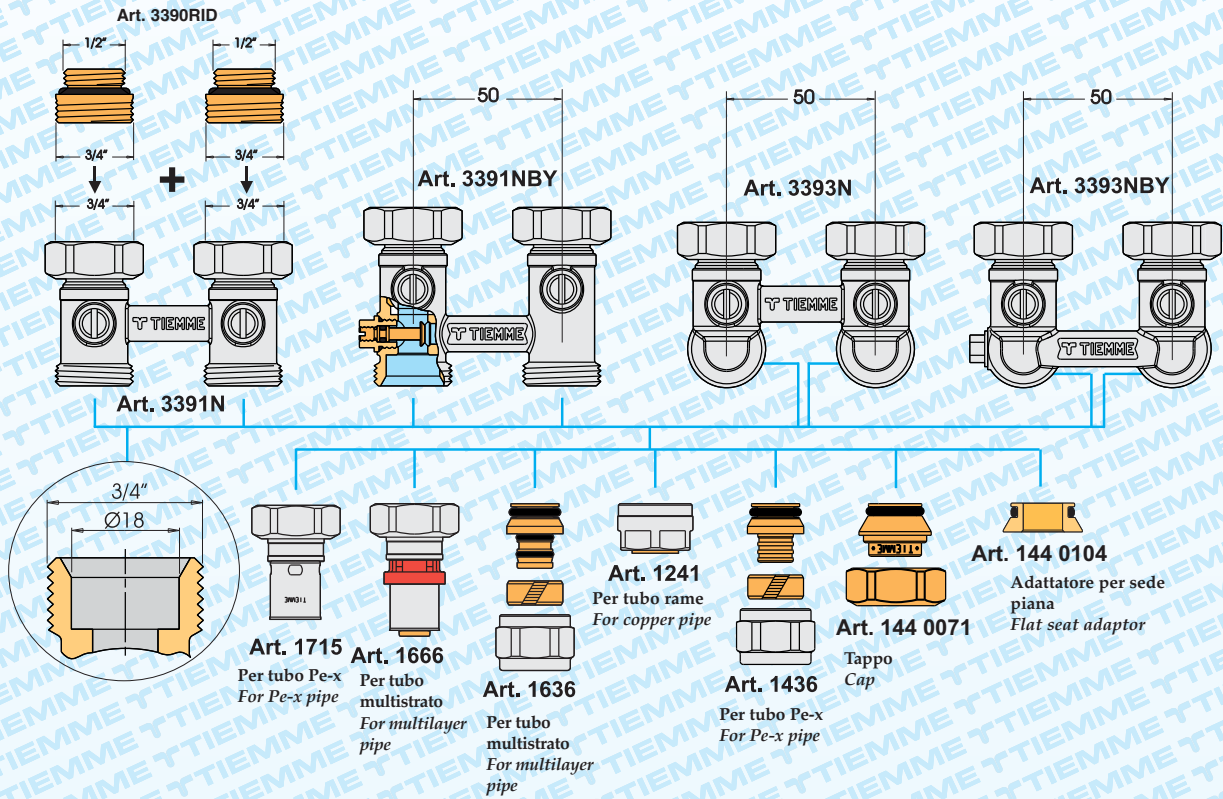

Per tabella giri di serraggio vedi pag 267-268 Cap. 17
 For nut tightnings table see pag 267-268 Chap. 17



ART. 9550
Manopola per valvole termostattabili serie 3300
Plastic head for thermostatic valves series 3300

| CODICE Code | TIPO Size | PREZZO Price € | CONF. Unit/Box |
|----------------|--------------|-------------------|-------------------|
| 327 0006 | - | 1,52 | 5/50 |



ART. 9552
Manopola per valvole manuali serie Excel
Plastic head for manual valves series Excel

| CODICE Code | TIPO Size | PREZZO Price € | CONF. Unit/Box |
|----------------|--------------|-------------------|-------------------|
| 327 0008 | - | 0,48 | 5/50 |



ART. 9552P06
Manopola per valvole manuali serie Maxima
Plastic head for Maxima manual valves

| CODICE Code | TIPO Size | PREZZO Price € | CONF. Unit/Box |
|----------------|--------------|-------------------|-------------------|
| 327 0038 | - | 0,56 | 5/50 |



ART. 3338
Bocchettone con guarnizione
Tail pieces with seal

| CODICE Code | TIPO Size | PREZZO Price € | CONF. Unit/Box |
|----------------|--------------|-------------------|-------------------|
| 327 0007 | 3/8" | 3,26 | 5/100 |
| 327 0003 | 1/2" | 3,36 | 5/100 |
| 327 0005 | 3/4" | 5,38 | 5/100 |



ART. 3340
Rosone universale
Universal cover for pipe

| CODICE Code | TIPO Size | PREZZO Price € | CONF. Unit/Box |
|----------------|--------------|-------------------|-------------------|
| 327 0001 | Ø10 - Ø18 | 0,71 | 10 |



ART. 3345N *
Dado + ogiva in ottone con attacco ferro G1/2" - per tubo rame
Nut with brass rings, iron pipe connection G1/2" - for copper pipe

| CODICE Code | TIPO Size | PREZZO Price € | CONF. Unit/Box |
|----------------|--------------|-------------------|-------------------|
| 327 0010 | 10 x 1/2" | 2,01 | 10 |
| 327 0009 | 12 x 1/2" | 1,99 | 10 |
| 327 0011 | 14 x 1/2" | 1,94 | 10 |
| 327 0002 | 15 x 1/2" | 1,94 | 10 |
| 327 0012 | 16 x 1/2" | 1,94 | 10 |

* utilizzare con valvole e detentori serie 3300
to be used with valves and lockshields 3300 series



ART. 3342
Rosone universale doppio con interasse 38 mm
Double universal cover for pipe with distance between centres 38 mm

| CODICE Code | TIPO Size | PREZZO Price € | CONF. Unit/Box |
|----------------|--------------|-------------------|-------------------|
| 327 0004 | Ø10 - Ø18 | 2,06 | 1/50 |



ART. 9760
Chiave esagonale per DUO FLOW
Exagonal spanner for DUO FLOW

| CODICE Code | TIPO Size | PREZZO Price € | CONF. Unit/Box |
|----------------|----------------|-------------------|-------------------|
| 338 0004 | unica - single | 1,25 | 10 |

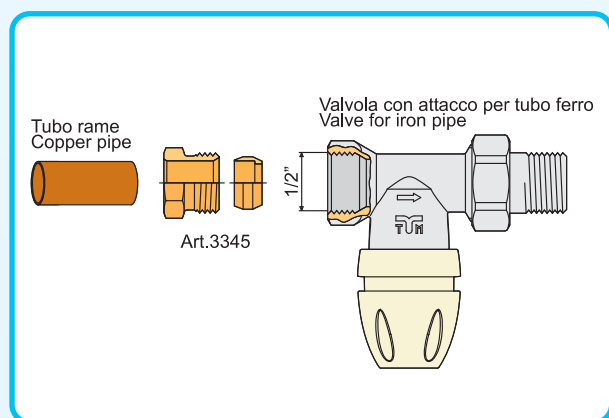



ART. 3350
Valvola di sfiato per radiatori
Air vent valve for radiators

| CODICE Code | TIPO Size | PREZZO Price € | CONF. Unit/Box |
|----------------|--------------|-------------------|-------------------|
| 198 0021 | 1/8" | vedi cap. 21 | 10/500 |
| 198 0020 | 1/4" | vedi cap. 21 | 10/500 |
| 198 0015 | 3/8" | vedi cap. 21 | 10/500 |
| 198 0016 | 1/2" | vedi cap. 21 | 10/500 |



ART. 3351
Valvola di sfiato per radiatori
con anello di pretenuta
Air vent valve with O-ring for radiators

| CODICE Code | TIPO Size | PREZZO Price € | CONF. Unit/Box |
|----------------|--------------|-------------------|-------------------|
| 198 0010 | 1/4" | vedi cap. 21 | 10/500 |
| 198 0008 | 3/8" | vedi cap. 21 | 10/500 |
| 198 0006 | 1/2" | vedi cap. 21 | 10/500 |



ART. 3352
Valvola di sfiato per radiatori
con taglio cacciavite
Air vent valve with screwdriver cut for radiators

| CODICE Code | TIPO Size | PREZZO Price € | CONF. Unit/Box |
|----------------|--------------|-------------------|-------------------|
| 198 0018 | 1/2" | vedi cap. 21 | 10/500 |



ART. 1829Z
Coppia staffette fissaggio
radiatore
Couple of brackets for radiators

| CODICE Code | TIPO Size | PREZZO Price € | CONF. Unit/Box |
|----------------|----------------|-------------------|-------------------|
| 076 0002 | unica - single | 1,71 | 25/100 |