



13



13/A

RACCORDI A
PRESSARE
PER ACQUA

PRESS-FITTINGS
FOR WATER

RACCORDI MULTIPINZA FINO A Ø 32
FITTING MULTI-JAWS UP TO Ø 32

13

www.tiemme.com

COPYRIGHT

serie 1650

RACCORDI A
PRESSARE
PER TUBO
MULTISTRATO
"AL-COBRAPEX"
ACQUA E GAS

PRESS-FITTINGS
FOR MULTILAYER
PIPE WATER AND
GAS

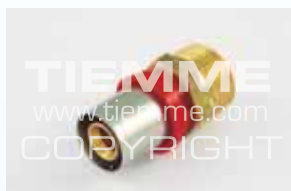

ART. 1650CT
Raccordo diritto maschio
Straight fitting male

CODICE Code	TIPO Size	PREZZO Price €	CONF. Unit/Box
166 0004	16 x 2,0 - 1/2"	2,11	10/100
166 0031	16 x 2,0 - 3/4"	3,86	10/100
166 0006	20 x 2,0 - 1/2"	2,51	10/100
166 0018	20 x 2,0 - 3/4"	3,41	10/100
166 0070	25 x 2,5 - 3/4"	5,82	10/50
166 0071	25 x 2,5 - 1"	7,67	5/25
166 0012	26 x 3,0 - 3/4"	4,75	10/50
166 0064	26 x 3,0 - 1"	7,67	5/25
166 0021	32 x 3,0 - 1"	8,77	5/25



ART. 1651CT
Raccordo diritto doppio
Straight fitting double

CODICE Code	TIPO Size	PREZZO Price €	CONF. Unit/Box
166 0015	16 x 2,0 - 16 x 2,0	3,53	10/100
166 0019	20 x 2,0 - 20 x 2,0	4,57	10/100
166 0072	25 x 2,5 - 25 x 2,5	7,28	5/50
166 0026	26 x 3,0 - 26 x 3,0	6,14	5/50
166 0028	32 x 3,0 - 32 x 3,0	10,62	5/25



ART. 1652CT
Raccordo diritto femmina
Straight fitting female

CODICE Code	TIPO Size	PREZZO Price €	CONF. Unit/Box
166 0009	16 x 2,0 - 1/2"	2,69	10/100
166 0010	20 x 2,0 - 1/2"	3,65	10/100
166 0016	26 x 3,0 - 3/4"	5,88	5/25
166 0065	26 x 3,0 - 1"	8,03	5/25
166 0066	32 x 3,0 - 1"	9,21	5/25



ART. 1654CT
Raccordo curvo maschio
Elbow male

CODICE Code	TIPO Size	PREZZO Price €	CONF. Unit/Box
166 0008	16 x 2,0 - 1/2"	4,35	10/100
166 0022	20 x 2,0 - 1/2"	4,84	10/100
166 0029	20 x 2,0 - 3/4"	6,36	10/50
166 0025	26 x 3,0 - 3/4"	7,00	5/50
166 0030	32 x 3,0 - 1"	14,26	5/25



ART. 1657CT
Raccordo a T
Tee

CODICE Code	TIPO Size	PREZZO Price €	CONF. Unit/Box
166 0001	16 x 2,0 - 16 x 2,0 - 16 x 2,0	5,47	10/50
166 0002	20 x 2,0 - 20 x 2,0 - 20 x 2,0	6,73	5/50
166 0074	25 x 2,5 - 25 x 2,5 - 25 x 2,5	13,95	5/25
166 0075	32 x 3,0 - 25 x 2,5 - 32 x 3,0	18,98	5/25
166 0076	32 x 3,0 - 25 x 2,5 - 25 x 2,5	18,80	5/25
166 0078	32 x 3,0 - 26 x 3,0 - 26 x 3,0	18,80	5/25
166 0077	32 x 3,0 - 26 x 3,0 - 32 x 3,0	18,98	5/25
166 0017	26 x 3,0 - 26 x 3,0 - 26 x 3,0	12,71	5/25
166 0024	32 x 3,0 - 32 x 3,0 - 32 x 3,0	19,93	5/25



ART. 1659CT
Raccordo a T femmina
Tee female

CODICE Code	TIPO Size	PREZZO Price €	CONF. Unit/Box
166 0011	16 x 2,0 - 1/2" - 16 x 2,0	6,20	10/100
166 0020	20 x 2,0 - 1/2" - 20 x 2,0	6,47	10/100
166 0032	26 x 3,0 - 3/4" - 26 x 3,0	14,60	5/25
166 0034	32 x 3,0 - 1" - 32 x 3,0	20,95	5/25



ART. 1656DFCT
Raccordo curvo femmina con
flangia 2 fori
*Wallplate elbow female
with 2 holes*
H = 40 mm

CODICE Code	TIPO Size	PREZZO Price €	CONF. Unit/Box
166 0005	16 x 2,0 - 1/2"	4,68	10/50
166 0023	20 x 2,0 - 1/2"	6,20	10/50



ART. 1655CT
Raccordo curvo femmina
Elbow female

CODICE Code	TIPO Size	PREZZO Price €	CONF. Unit/Box
166 0003	16 x 2,0 - 1/2"	3,25	10/100
166 0007	20 x 2,0 - 1/2"	3,93	10/100
166 0073	25 x 2,5 - 3/4"	8,88	5/25
166 0014	26 x 3,0 - 3/4"	8,88	5/25
166 0027	32 x 3,0 - 1"	15,66	5/25

RACCORDI A PRESSARE PER TUBO MULTISTRATO "AL-COBRAPEX"

PRESS-FITTINGS FOR MULTILAYER PIPE "AL-COBRAPEX"



ART. 1650
Raccordo diritto maschio
Straight fitting male

CODICE Code	TIPO Size	PREZZO Price €	CONF. Unit/Box
165 0191	14 x 1/2"	4,45	10/100
165 0262	16 x 3/8"	2,98	10/100
165 0009	16 x 1/2"	2,36	10/100
165 0091	16 x 3/4"	4,34	10/100
165 0087	18 x 1/2"	3,14	10/100
165 0206	18 x 3/4"	4,46	10/100
165 0014	20 x 1/2"	2,84	10/100
165 0015	20 x 3/4"	3,71	10/100
165 0219	25 x 3/4"	6,20	10/50
165 0245	25 x 1"	8,29	5/25
165 0180	26 x 1/2"	5,57	10/50
165 0007	26 x 3/4"	5,22	10/50
165 0027	26 x 1"	8,29	5/25
165 0032	32 x 1"	9,52	5/25
165 0121	32 x 1 1/4	17,04	5/25
165 0065	40 x 1 1/4	14,91	5/25
165 0084	50 x 1 1/2	26,75	2/16
165 0089	63 x 2"	39,88	2/16



ART. 1651
Raccordo diritto doppio
Straight fitting double

CODICE Code	TIPO Size	PREZZO Price €	CONF. Unit/Box
165 0159	14 x 14	6,76	10/100
165 0016	16 x 16	3,67	10/100
165 0101	18 x 18	6,35	10/100
165 0022	20 x 20	4,74	10/100
165 0212	25 x 25	8,10	5/50
165 0037	26 x 26	6,83	5/50
165 0051	32 x 32	11,84	5/25
165 0059	40 x 40	17,36	5/25
165 0060	50 x 50	33,05	2/16
165 0068	63 x 63	52,48	2/16
Raccordo diritto doppio ridotto - <i>Reduced straight fitting double</i>			
165 0221	16 x 14	6,25	10/100
165 0193	18 x 16	5,18	10/100
165 0040	20 x 16	4,96	10/100
165 0177	20 x 18	7,25	10/100
165 0333	25 x 16	7,60	10/100
165 0228	25 x 20	8,78	10/100
165 0093	26 x 16	7,60	10/100
165 0247	26 x 18	9,26	10/100
165 0052	26 x 20	8,78	10/100
165 0337	26 x 25	8,17	5/50
165 0186	32 x 16	13,49	5/25
165 0115	32 x 20	12,18	5/25
165 0288	32 x 25	13,15	5/25
165 0067	32 x 26	13,15	5/25
165 0150	40 x 26	17,85	5/25
165 0103	40 x 32	17,80	5/25
165 0154	50 x 32	30,71	2/16
165 0126	50 x 40	30,20	2/16
165 0170	63 x 40	49,58	2/16
165 0145	63 x 50	51,38	2/16



ART. 1651KB
Raccordo diritto doppio tubo multistrato/rame a compressione
Straight fitting double multilayer pipe/compression copper pipe

CODICE Code	TIPO Size	PREZZO Price €	CONF. Unit/Box
165 0120	16 x 2 - Ø 15	5,92	10/100
165 0164	20 x 2 - Ø 22	7,43	10/100
165 0236	26 x 3 - Ø 22	9,94	5/25
165 0335	26 x 3 - Ø 28	10,70	5/25



ART. 1651CY
Raccordo diritto tubo multistrato/tubetto cilindrico
Straight fitting multilayer pipe/cylindrical pipe

CODICE Code	TIPO Size	PREZZO Price €	CONF. Unit/Box
165 0347	16 x Ø 12	2,22	10/100
165 0317	16 x Ø 15	2,27	10/100
165 0334	20 x Ø 15	2,96	10/100
165 0313	20 x Ø 22	3,86	10/100
165 0340	26 x Ø 22	4,21	10/100
165 0345	26 x Ø 28	5,16	10/100



ART. 1653KB
Raccordo curvo doppio tubo multistrato/rame a compressione
Elbow double multilayer pipe/compression copper pipe

CODICE Code	TIPO Size	PREZZO Price €	CONF. Unit/Box
165 0283	16 x 2 - Ø 15	7,11	10/100
165 0284	20 x 2 - Ø 22	10,21	10/100
165 0324	26 x 3 - Ø 22	12,82	5/25

N.B.: A richiesta disponibili in versione stagnata
Tin-plated version available on request

RACCORDI A PRESSARE PER TUBO MULTISTRATO "AL-COBRAPEX"

PRESS-FITTINGS FOR MULTILAYER PIPE "AL-COBRAPEX"



ART. 1652
Raccordo diritto femmina
Straight fitting female

CODICE Code	TIPO Size	PREZZO Price €	CONF. Unit/Box
165 0225	14 x 1/2"	4,42	10/100
165 0030	16 x 1/2"	2,84	10/100
165 0116	16 x 3/4"	6,51	10/100
165 0113	18 x 1/2"	5,06	10/100
165 0211	18 x 3/4"	6,89	10/100
165 0025	20 x 1/2"	3,87	10/100
165 0033	20 x 3/4"	4,99	10/100
165 0253	25 x 3/4"	7,18	5/25
165 0268	25 x 1"	9,43	5/25
165 0020	26 x 3/4"	6,52	5/25
165 0053	26 x 1"	9,43	5/25
165 0050	32 x 1"	10,63	5/25
165 0139	32 x 1"1/4	18,29	5/25
165 0094	40 x 1"1/4	16,81	5/25
165 0122	50 x 1"1/2	31,72	2/16



ART. 1654
Raccordo curvo maschio
Elbow male

CODICE Code	TIPO Size	PREZZO Price €	CONF. Unit/Box
165 0231	14 x 1/2"	6,70	10/100
165 0010	16 x 1/2"	4,38	10/100
165 0090	18 x 1/2"	6,68	10/100
165 0207	18 x 3/4"	9,91	10/100
165 0029	20 x 1/2"	4,73	10/100
165 0044	20 x 3/4"	6,33	10/50
165 0280	25 x 3/4"	8,28	5/50
165 0046	26 x 3/4"	7,43	5/50
165 0074	32 x 1"	15,12	5/25
165 0152	40 x 1"1/4	25,69	5/25
165 0185	50 x 1"1/2	49,78	2/8
165 0203	63 x 2"	58,14	2/8



ART. 1661
Curva 45°
45° Elbow

CODICE Code	TIPO Size	PREZZO Price €	CONF. Unit/Box
165 0197	26 x 26	19,23	5/25
165 0176	32 x 32	21,76	5/25
165 0124	40 x 40	62,05	5/25
165 0144	50 x 50	67,51	1/10
165 0172	63 x 63	89,68	1/5



ART. 1653
Raccordo curvo doppio
Elbow double

CODICE Code	TIPO Size	PREZZO Price €	CONF. Unit/Box
165 0218	14 x 14	7,18	10/100
165 0011	16 x 16	4,30	10/100
165 0107	18 x 18	7,14	10/100
165 0348	20 x 16	5,41	10/100
165 0006	20 x 20	5,57	10/100
165 0140	25 x 25	10,10	5/25
165 0003	26 x 26	9,20	5/25
165 0013	32 x 32	13,46	5/25
165 0036	40 x 40	22,28	5/25
165 0043	50 x 50	57,62	2/8
165 0056	63 x 63	68,18	2/8



ART. 1653CY
Raccordo curvo tubo multistrato/tubetto cilindrico L=60 mm
Elbow multilayer pipe Cylindrical pipe L=60 mm

CODICE Code	TIPO Size	PREZZO Price €	CONF. Unit/Box
165 0278	16 x Ø12 L=60 mm	6,66	10/100



ART. 1655
Raccordo curvo femmina
Elbow female

CODICE Code	TIPO Size	PREZZO Price €	CONF. Unit/Box
165 0135	14 x 1/2"	7,24	10/100
165 0001	16 x 1/2"	4,17	10/100
165 0049	18 x 1/2"	6,85	10/100
165 0204	18 x 3/4"	9,34	10/100
165 0012	20 x 1/2"	4,63	10/100
165 0035	20 x 3/4"	7,41	10/50
165 0210	25 x 3/4"	9,57	5/25
165 0023	26 x 3/4"	9,57	5/25
165 0080	26 x 1"	17,07	5/25
165 0057	32 x 1"	17,50	5/25
165 0114	40 x 1"1/4	27,64	5/25
165 0163	50 x 1"1/2	55,97	2/8

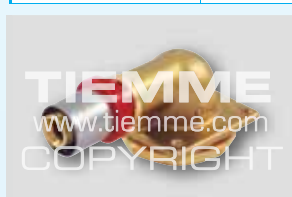

ART. 1662
Flangia per cassetta W.C. incasso
Wallplate elbow female for built-in WC

CODICE Code	TIPO Size	PREZZO Price €	CONF. Unit/Box
165 0175	16 x 1/2"	13,26	10/50
165 0353	18 x 1/2"	14,09	10/50
165 0260	20 x 1/2"	13,27	5/25

N.B.: A richiesta disponibili in versione stagnata
Tin-plated version available on request

RACCORDI A PRESSARE PER TUBO MULTISTRATO "AL-COBRAPEX"

PRESS-FITTINGS FOR MULTILAYER PIPE "AL-COBRAPEX"



ART. 1656

Raccordo curvo femmina con flangia a 3 fori
Wallplate elbow female with 3 holes
H = 53 mm

CODICE Code	TIPO Size	PREZZO Price €	CONF. Unit/Box
165 0263	14 x 1/2"	7,80	10/50
165 0004	16 x 1/2"	5,60	10/50
165 0100	18 x 1/2"	7,91	10/50
165 0038	20 x 1/2"	7,24	5/50



ART. 1656SM

Raccordo curvo femmina con flangia a 3 fori collo basso
Wallplate elbow female with 3 holes
H = 40 mm

CODICE Code	TIPO Size	PREZZO Price €	CONF. Unit/Box
165 0243	14 x 1/2"	7,71	10/50
165 0021	16 x 1/2"	5,52	10/50
165 0296	18 x 1/2"	7,63	5/50
165 0088	20 x 1/2"	7,70	5/50



ART. 1656KB

Raccordo curvo con flangia per tubi multistrato / rame
Wallplate elbow for multilayer/copper pipes
H = 53 mm

CODICE Code	TIPO Size	PREZZO Price €	CONF. Unit/Box
165 0349	14 x 15	9,65	10/50
165 0306	16 x 15	9,74	10/50
165 0343	20 x 15	10,12	5/50



ART. 1676

Raccordo curvo femmina doppio con flangia
Double wallplate elbow female
H = 53 mm

CODICE Code	TIPO Size	PREZZO Price €	CONF. Unit/Box
165 0111	16 x 1/2" x 16	12,41	10/50
165 0255	18 x 1/2" x 18	13,16	10/50
165 0171	20 x 1/2" x 20	13,41	5/50



ART. 1656XL

Raccordo curvo femmina con flangia a 3 fori collo alto
Wallplate elbow female with 3 holes
H = 77 mm

CODICE Code	TIPO Size	PREZZO Price €	CONF. Unit/Box
165 0346	14 x 1/2"	10,07	10/50
165 0097	16 x 1/2"	9,35	10/50



ART. 1676SM

Raccordo curvo femmina doppio con flangia collo basso
Double wallplate elbow female
H = 40 mm

CODICE Code	TIPO Size	PREZZO Price €	CONF. Unit/Box
165 0371	14 x 1/2"	12,54	10/50
165 0215	16 x 1/2"	12,37	10/50
165 0373	18 x 1/2"	13,17	5/50
165 0267	20 x 1/2"	13,37	5/50



ART. 1676KB

Raccordo curvo doppio con flangia per tubi multistrato / rame
Double wallplate elbow for multilayer/copper pipes
H = 53 mm

CODICE Code	TIPO Size	PREZZO Price €	CONF. Unit/Box
165 0372	16 x 15 x 16	12,60	10/50
165 0326	20 x 15 x 20	13,73	5/50



ART. 1687

Raccordo a croce
Cross

CODICE Code	TIPO Size	PREZZO Price €	CONF. Unit/Box
165 0307	20 x 16 x 20 x 16	16,50	5/25
165 0331	20 x 20 x 16 x 16	16,55	5/25
165 0320	20 x 20 x 20 x 20	17,06	5/25
165 0378	25 x 16 x 20 x 16	17,28	5/20
165 0289	25 x 20 x 16 x 16	17,17	5/20
165 0379	25 x 20 x 20 x 20	22,83	5/20
165 0380	26 x 16 x 20 x 16	17,28	5/20
165 0322	26 x 20 x 16 x 16	17,17	5/20
165 0327	26 x 20 x 20 x 20	22,83	5/20



ART. 1688

Collettore a 5 vie
5 ways manifold

CODICE Code	TIPO Size	PREZZO Price €	CONF. Unit/Box
165 0784	20 x 20 x 16 x 16 x 16	19,49	5/20
165 0785	20 x 20 x 20 x 20 x 20	21,00	5/20
165 0786	25 x 20 x 16 x 16 x 16	19,97	5/20
165 0819	25 x 20 x 20 x 20 x 20	20,15	5/20
165 0787	26 x 20 x 16 x 16 x 16	19,97	5/20
165 0788	26 x 20 x 20 x 20 x 20	20,15	5/20

N.B.: A richiesta disponibili in versione stagnata
Tin-plated version available on request

RACCORDI A PRESSARE PER TUBO MULTISTRATO "AL-COBRAPEX"

PRESS-FITTINGS FOR MULTILAYER PIPE "AL-COBRAPEX"



ART. 1657
Raccordo a T
Tee

CODICE Code	TIPO Size	PREZZO Price €	CONF. Unit/Box
165 0190	14 x 14 x 14	8,48	10/50
165 0002	16 x 16 x 16	5,67	10/50
165 0042	18 x 18 x 18	9,79	10/50
165 0005	20 x 20 x 20	7,08	5/50
165 0181	25 x 25 x 25	14,21	5/25
165 0018	26 x 26 x 26	12,94	5/25
165 0058	32 x 32 x 32	20,94	5/25
165 0083	40 x 40 x 40	30,26	1/20
165 0108	50 x 50 x 50	54,09	1/10
165 0109	63 x 63 x 63	92,96	1/5
Raccordo a T ridotto - Tee reduced			
165 0265	16 x 14 x 14	9,72	10/50
165 0249	16 x 14 x 16	9,57	10/50
165 0070	16 x 20 x 16	9,25	5/50
165 0350	16 x 25 x 16	15,85	5/25
165 0351	16 x 26 x 16	15,85	5/25
165 0276	18 x 16 x 16	8,89	10/50
165 0169	18 x 16 x 18	10,54	10/50
165 0019	20 x 16 x 16	8,56	5/50
165 0008	20 x 16 x 20	7,38	5/50
165 0232	20 x 18 x 18	11,88	5/50
165 0188	20 x 18 x 20	11,70	5/50
165 0045	20 x 20 x 16	9,33	5/50
165 0242	20 x 20 x 18	9,95	5/50
165 0825	20 x 25 x 20	15,38	5/25
165 0069	20 x 26 x 20	15,38	5/25
165 0290	25 x 16 x 16	15,38	5/25
165 0821	25 x 16 x 20	13,10	5/25
165 0220	25 x 16 x 25	15,41	5/25
165 0826	25 x 20 x 16	15,17	5/25
165 0213	25 x 20 x 20	15,07	5/25
165 0201	25 x 20 x 25	15,34	5/25
165 0321	25 x 25 x 16	15,65	5/25
165 0244	25 x 25 x 20	16,34	5/25
165 0822	25 x 32 x 25	23,12	5/25
165 0102	26 x 16 x 16	15,38	5/25
165 0078	26 x 16 x 20	13,10	5/25
165 0026	26 x 16 x 26	15,41	5/25
165 0226	26 x 18 x 26	15,96	5/25
165 0132	26 x 20 x 16	15,17	5/25
165 0047	26 x 20 x 20	15,07	5/25
165 0017	26 x 20 x 26	15,34	5/25
165 0127	26 x 26 x 16	15,65	5/25
165 0063	26 x 26 x 20	16,34	5/25
165 0165	26 x 32 x 26	23,12	5/25
165 0073	32 x 16 x 32	20,71	5/25
165 0156	32 x 20 x 20	20,48	5/25
165 0827	32 x 20 x 25	20,66	5/25
165 0136	32 x 20 x 26	20,66	5/25
165 0055	32 x 20 x 32	19,84	5/25

165 0823	32 x 25 x 25	20,12	5/25
165 0828	32 x 25 x 32	19,94	5/25
165 0824	32 x 32 x 25	23,59	5/25
165 0075	32 x 26 x 26	20,12	5/25
165 0064	32 x 26 x 32	19,94	5/25
165 0143	32 x 32 x 20	25,08	5/25
165 0119	32 x 32 x 26	23,59	5/25
165 0199	32 x 40 x 32	30,80	1/20
165 0195	40 x 16 x 40	33,69	1/20
165 0096	40 x 20 x 40	33,94	1/20
165 0829	40 x 25 x 40	34,68	1/20
165 0081	40 x 26 x 40	34,68	1/20
165 0128	40 x 32 x 32	31,44	1/20
165 0095	40 x 32 x 40	30,70	1/20
165 0830	40 x 40 x 25	34,71	1/20
165 0222	40 x 40 x 26	34,71	1/20
165 0192	40 x 40 x 32	34,25	1/20
165 0259	40 x 50 x 40	52,50	1/10
165 0308	50 x 16 x 50	47,19	1/10
165 0168	50 x 20 x 50	52,43	1/10
165 0831	50 x 25 x 50	49,13	1/10
165 0117	50 x 26 x 50	49,13	1/10
165 0123	50 x 32 x 50	51,91	1/10
165 0196	50 x 40 x 40	54,90	1/10
165 0148	50 x 40 x 50	52,45	1/10
165 0230	50 x 50 x 32	60,60	1/10
165 0224	50 x 50 x 40	61,51	1/10
165 0832	63 x 25 x 63	95,59	1/5
165 0086	63 x 26 x 63	95,59	1/5
165 0129	63 x 32 x 63	94,92	1/5
165 0147	63 x 40 x 63	95,65	1/5
165 0166	63 x 50 x 63	95,79	1/5



ART. 1658
T maschio
Tee male

CODICE Code	TIPO Size	PREZZO Price €	CONF. Unit/Box
165 0339	14 x 1/2" x 14	10,25	10/100
165 0085	16 x 1/2" x 16	8,87	10/100
165 0258	18 x 1/2" x 18	11,68	10/100
165 0318	18 x 3/4" x 18	11,89	10/100
165 0092	20 x 1/2" x 20	10,09	5/100
165 0131	20 x 3/4" x 20	10,91	5/50
165 0149	26 x 1/2" x 26	17,91	5/25
165 0098	26 x 3/4" x 26	17,50	5/25
165 0167	26 x 1" x 26	20,59	5/25
165 0657	32 x 3/4" x 32	28,34	5/25
165 0155	32 x 1" x 32	20,99	5/25
165 0209	40 x 1" 1/4 x 40	33,73	1/20

● NEW

RACCORDI A PRESSARE PER TUBO MULTISTRATO "AL-COBRAPEX"

PRESS-FITTINGS FOR MULTILAYER PIPE "AL-COBRAPEX"



ART. 1656ISOL01
Set isolamento acustico
Acoustic insulating set

DA UTILIZZARE CON ART. 1656
TO BE USED WITH ART. 1656

CODICE Code	TIPO Size	PREZZO Price €	CONF. Unit/Box
165 0305	1/2"	4,09	10/50



ART. 1656ISOL02
Set isolamento acustico
Acoustic insulating set

DA UTILIZZARE CON ART. 1656XL
TO BE USED WITH ART. 1656XL

CODICE Code	TIPO Size	PREZZO Price €	CONF. Unit/Box
165 0344	1/2"	4,09	10/50

SET DI ISOLAMENTO ACUSTICO PER RACCORDI FLANGIATI *Acoustic insulating set for wallplate fittings*

I set di isolamento acustico permettono di ridurre al minimo la rumorosità dell'impianto garantendo il massimo del comfort anche in presenza di pareti sottili o pareti in cartongesso in accordo con la normativa DIN 4109.

The acoustic insulating set allow to reduce to the noise of the water circulation giving the maximum comfort even in presence of thin walls or pesterwork as (DIN 4109 requirements)

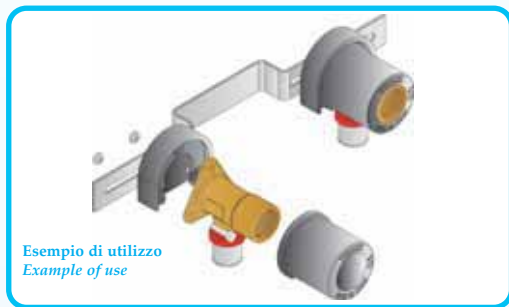

ART. 1659
T femmina
Tee female

CODICE Code	TIPO Size	PREZZO Price €	CONF. Unit/Box
165 0234	14 x 1/2" x 14	11,42	10/100
165 0031	16 x 1/2" x 16	8,13	10/100
165 0104	18 x 1/2" x 18	9,73	10/100
165 0271	18 x 3/4" x 18	12,60	10/50
165 0039	20 x 1/2" x 20	8,96	5/50
165 0079	20 x 3/4" x 20	11,35	5/50
165 0833	25 x 1/2" x 25	17,87	5/25
165 0261	25 x 3/4" x 25	16,35	5/25
165 0105	26 x 1/2" x 26	17,87	5/25
165 0048	26 x 3/4" x 26	16,35	5/25
165 0142	32 x 1/2" x 32	25,64	5/25
165 0125	32 x 3/4" x 32	23,27	5/25
165 0054	32 x 1" x 32	23,65	5/25
165 0118	40 x 1" x 40	29,76	1/20
165 0112	40 x 1"1/4" x 40	32,82	1/20
165 0130	50 x 3/4" x 50	48,62	1/10
165 0146	50 x 1" x 50	50,05	1/10
165 0162	63 x 1" x 63	85,26	1/5



ART. 1665
Raccordo diritto con girello e guarnizione piana
Straight fitting with loose nut and flat washer

CODICE Code	TIPO Size	PREZZO Price €	CONF. Unit/Box
165 0301	14 x 1/2"	4,03	10/100
165 0256	16 x 3/8"	3,14	10/100
165 0034	16 x 1/2"	3,06	10/100
165 0133	16 x 3/4"	4,69	10/100
165 0297	16 x 1"	13,05	10/100
165 0241	18 x 1/2"	4,20	10/100
165 0328	18 x 3/4"	5,78	10/100
165 0061	20 x 1/2"	3,78	10/100
165 0062	20 x 3/4"	5,16	10/100
165 0303	25 x 3/4"	14,07	2/100
165 0233	25 x 1"	15,16	2/50
165 0072	26 x 3/4"	14,07	2/100
165 0071	26 x 1"	15,16	2/50
165 0294	26 x 1"1/4	18,23	2/90
165 0354	32 x 3/4"	16,63	2/100
165 0134	32 x 1"	18,23	2/100
165 0161	32 x 1"1/4	18,77	2/80
165 0240	32 x 1"1/2	23,51	1/50
165 0239	40 x 1"1/2	24,03	1/25
165 0257	50 x 2"	40,33	1/30
165 0275	63 x 2"1/2	58,23	1/20

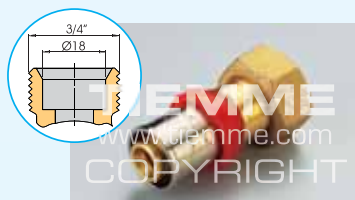

ART. 1666
Raccordo diritto con girello su attacchi 3/4" x 18 (EUROCONO)
Straight fitting with loose nut for 3/4" x 18 connections (EUROCONUS)

CODICE Code	TIPO Size	PREZZO Price €	CONF. Unit/Box
165 0304	14 x 3/4"	10,33	10/100
165 0076	16 x 3/4"	9,55	10/100
165 0277	18 x 3/4"	10,37	10/100
165 0110	20 x 3/4"	9,97	10/100

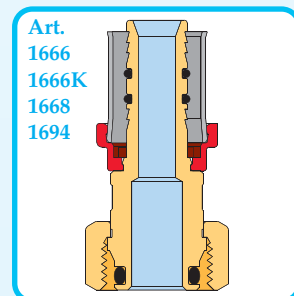
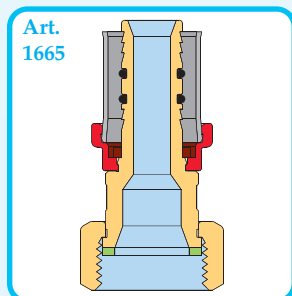

N.B.: A richiesta disponibili in versione stagnata
Tin-plated version available on request

RACCORDI A PRESSARE PER TUBO MULTISTRATO "AL-COBRAPEX"

PRESS-FITTINGS FOR MULTILAYER PIPE "AL-COBRAPEX"

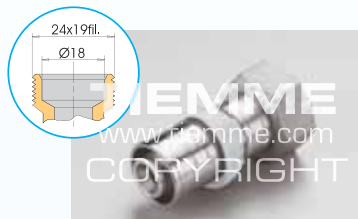

ART. 1666K
Raccordo diritto cromato con girello su attacchi 24x19 (Ø18)
Chrome-plated straight fitting with loose nut for 24x19(Ø18) connections

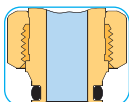

CODICE Code	TIPO Size	PREZZO Price €	CONF. Unit/Box
165 0158	16 x 24 (19 fil)	7,44	10/100
165 0198	18 x 24 (19 fil)	7,44	10/100
165 0272	20 x 24 (19 fil)	7,57	10/100



ART. 1667
Raccordo diritto maschio con girello
Straight fitting male with loose nut connector

CODICE Code	TIPO Size	PREZZO Price €	CONF. Unit/Box
165 0359	14 x 1/2"	8,22	10/100
165 0360	14 x 3/4"	9,10	10/100
165 0217	16 x 1/2"	8,26	10/100
165 0273	16 x 3/4"	9,17	10/100
165 0338	18 x 1/2"	8,21	10/100
165 0316	18 x 3/4"	9,10	10/100
165 0250	20 x 1/2"	8,24	5/100
165 0235	20 x 3/4"	9,12	5/100
165 0237	26 x 3/4"	11,20	5/25
165 0286	26 x 1"	14,97	5/25
165 0254	32 x 1"	23,13	1/40



ART. 1859
Adattatore per trasformare un attacco 3/4" x 18 (EUROCONO) in battuta piana
Adapter to have a plain on a 3/4" x 18 (EUROCONUS) connection

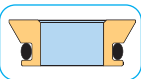

CODICE Code	TIPO Size	PREZZO Price €	CONF. Unit/Box
144 0104	3/4 x 18 (EUR)	vedi cap. 11	10/100



ART. 1660BP
Raccordo curvo con girello e guarnizione piana.
Elbow fitting with loose nut and flat seat

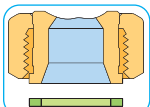

CODICE Code	TIPO Size	PREZZO Price €	CONF. Unit/Box
165 0352	16 x 1/2"	10,04	5/100
165 0179	16 x 3/4"	13,50	5/100
165 0178	20 x 3/4"	10,36	5/100
165 0274	26 x 3/4"	12,56	5/50

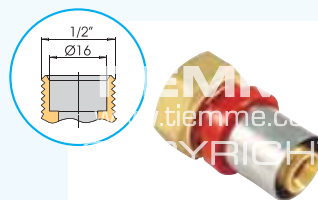

ART. 1668
Raccordo diritto con girello su attacchi 1/2" x 16 e M22 x 16
Straight fitting with loose nut for 1/2" x 16 or M22x16 connections

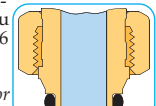

CODICE Code	TIPO Size	PREZZO Price €	CONF. Unit/Box
165 0314	14 x 1/2"	3,63	10/100
165 0028	16 x 1/2"	3,37	10/100
165 0269	18 x 1/2"	4,52	10/100
165 0077	20 x 1/2"	4,15	10/100
Nichelato - Nickel plated			
165 0364*	14 x M22	3,94	5/200
165 0299*	16 x M22	4,12	5/200

Per attacchi M22 x 16 / For M22 x 16 connections
* Fino ad esaurimento scorte / Until out of stock



ART. 1677
Terminale
Stop end

CODICE Code	TIPO Size	PREZZO Price €	CONF. Unit/Box
165 0279	14	5,71	10/100
165 0208	16	5,69	10/100
165 0336	18	6,20	10/100
165 0216	20	6,79	10/100
165 0282	26	7,64	5/50
165 0310	32	8,92	5/50
165 0315	40	15,24	5/25



ART. 1669
Raccordo curvo maschio con girello
Elbow fitting male with loose nut connector

CODICE Code	TIPO Size	PREZZO Price €	CONF. Unit/Box
165 0246	26 x 1"	16,85	5/25

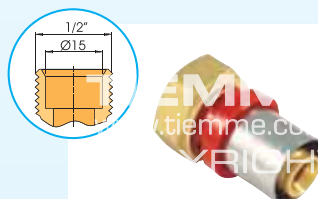

ART. 1694
Raccordo diritto con girello su attacchi 1/2" x 15
Straight fitting with loose nut for 1/2" x 15

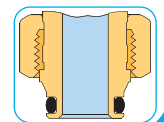

CODICE Code	TIPO Size	PREZZO Price €	CONF. Unit/Box
165 0381	14 x 1/2"	4,07	10/100
165 0141	16 x 1/2"	4,27	10/100
165 0382	18 x 1/2"	4,56	10/100
165 0264	20 x 1/2"	4,65	10/100

N.B.: A richiesta disponibili in versione stagnata
Tin-plated version available on request

RACCORDI A PRESSARE PER TUBO MULTISTRATO "AL-COBRAPEX"

PRESS-FITTINGS FOR MULTILAYER PIPE "AL-COBRAPEX"



ART. 1678
Staffa e raccordi terminali
Bracket and end fittings

CODICE Code	TIPO Size	PREZZO Price €	CONF. Unit/Box
165 0319	16x3/8" Int. 120 mm H = 37	17,55	1/25
165 0041	16x1/2" Int. 150 mm H = 37	17,78	1/25
165 0374	18x1/2" Int. 150 mm H = 37	17,93	1/25
165 0153	20x1/2" Int. 150 mm H = 37	17,90	1/25



ART. 1679KB
Staffa con raccordi terminali per tubo multistrato Ø 16 x 2,0/
tubo rame Ø 15
Bracket and end fittings for multilayer pipe Ø16 x 2,0/copper pipe Ø 15

CODICE Code	TIPO Size	PREZZO Price €	CONF. Unit/Box
165 0287	Int. 35 H=53	25,20	1/25
165 0375	Int. 35 H=65	25,86	1/25
165 0376	Int. 38 H=53	25,20	1/25
165 0377	Int. 38 H=65	25,86	1/25
165 0285	Int. 50 H=53	25,20	1/25
165 0329	Int. 50 H=65	25,86	1/25



ART. 1663
Staffa e raccordi per collegamenti in serie
Bracket and fittings for multiple connections

CODICE Code	TIPO Size	PREZZO Price €	CONF. Unit/Box
165 0251	18 x 1/2"	27,82	1/16

Interasse variabile / variable distance between centres:
72 - 115 - 155 mm
Fino ad esaurimento scorte / until out of stock



ART. 1663DI
Staffa e raccordi disassati per collegamenti in serie
Bracket and disaligned fittings for multiple connections

CODICE Code	TIPO Size	PREZZO Price €	CONF. Unit/Box
165 0082	16 x 1/2"	32,22	1/10
165 0820	18 x 1/2"	35,90	1/10
165 0137	20 x 1/2"	35,26	1/10

Interasse variabile / variable distance between centres:
72 - 115 - 155 mm



ART. 1664
Staffa e raccordi terminali
Bracket and end fittings

CODICE Code	TIPO Size	PREZZO Price €	CONF. Unit/Box
165 0024	16 x 1/2"	16,83	1/20
165 0214	18 x 1/2"	20,96	1/20
165 0106	20 x 1/2"	21,39	1/20

Interasse variabile / variable distance between centres:
72 - 115 - 155 mm



ART. 1664DI
Staffa e raccordi disassati per collegamenti terminali
Bracket and disaligned end fittings

CODICE Code	TIPO Size	PREZZO Price €	CONF. Unit/Box
165 0151	16 x 1/2"	33,89	1/10
165 0311	18 x 1/2"	37,42	1/10
165 0227	20 x 1/2"	37,08	1/10

Interasse variabile / variable distance between centres:
72 - 115 - 155 mm

ESEMPIO DI INSTALLAZIONE/INSTALLATION EXAMPLE

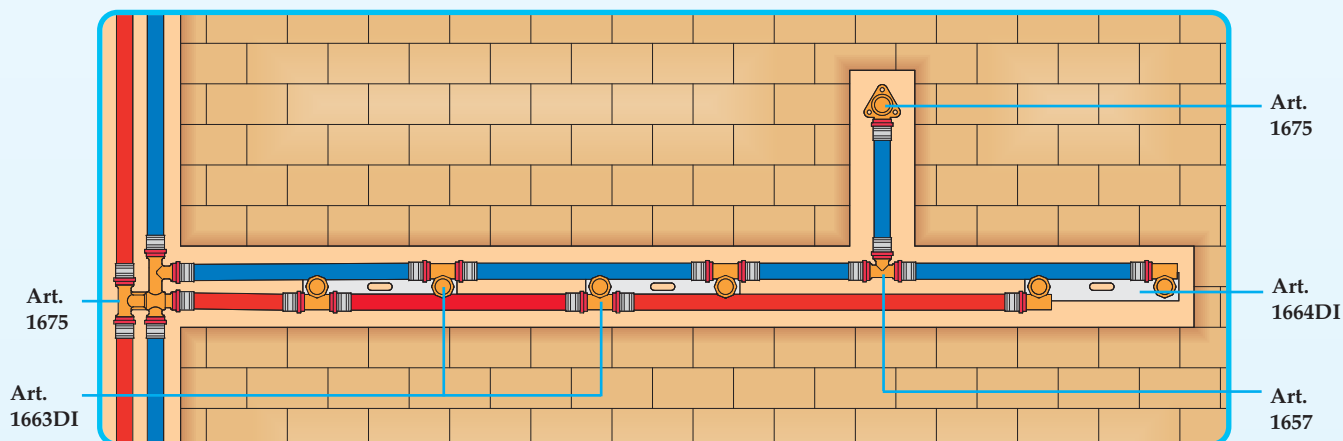

N.B.: A richiesta disponibili in versione stagnata
Tin-plated version available on request

RACCORDI A PRESSARE PER TUBO MULTISTRATO "AL-COBRAPEX"

PRESS-FITTINGS FOR MULTILAYER PIPE "AL-COBRAPEX"



ART. 1675ISOL

Isolante per Art. 1675
Insulating for Art. 1675

CODICE Code	TIPO Size	PREZZO Price €	CONF. Unit/Box
159 0045	unica - single	1,09	1/20



ART. 1675

T "By-pass"
Tee By-pass

CODICE Code	TIPO Size	PREZZO Price €	CONF. Unit/Box
165 0205	16 x 16 x 16	49,21	5/15
165 0183	20 x 16 x 16	49,10	5/15
165 0157	20 x 16 x 20	49,42	5/15
165 0174	20 x 20 x 20	49,48	5/15



ART. 1670X

Bussola Cobrapress Inox
Stainless steel Cobrapress sleeve

CODICE Code	TIPO Size	PREZZO Price €	CONF. Unit/Box
165 0342	14	0,83	10/400
165 0184	16	0,86	10/350
165 0302	18	1,24	10/300
165 0189	20	0,97	10/300
165 0295	25	1,41	10/200
165 0187	26	1,41	10/200
165 0238	32	1,91	10/150
165 0281	40	3,04	10/100
165 0291	50	6,43	1/50
165 0298	63	9,17	1/30



ART. 1671

Prolunga ripara tubi
Extension repairing pipes

CODICE Code	TIPO Size	PREZZO Price €	CONF. Unit/Box
165 0330	14	7,78	5/100
165 0202	16	8,22	5/100
165 0292	18	8,84	5/100
165 0200	20	9,52	5/100

Per istruzioni di utilizzo vedi pag. 165
For correct use see page 165

Disponibile anche con ghiera bianca (art. 1670B)
Also available with white plastic ring (art. 1670B)



ART. 1672

Curva terminale per radiatori
End elbow for radiator

CODICE Code	TIPO Size	PREZZO Price €	CONF. Unit/Box
Tubo rame Ø 15 - Copper pipe Ø 15 L = 200			
165 0099	16	11,20	5/50
999 0054	20	14,08	5/50
Tubo rame Ø 15 - Copper pipe Ø 15 L = 300			
165 0252	14	12,17	5/50
165 0066	16	11,96	5/50
165 0248	18	13,23	5/50
165 0194	20	13,52	5/50
Tubo rame Ø 15 - Copper pipe Ø 15 L = 1100			
165 0365	14	31,73	5/50
165 0223	16	31,73	5/50
165 0366	18	31,73	5/50
165 0312	20	31,73	5/50
Tubo rame Ø 14 - Copper pipe Ø 14 L = 300			
165 0138	16	13,80	5/50
165 0325	18	11,64	5/50



ART. 1673

T per radiatori
T for radiator

CODICE Code	TIPO Size	PREZZO Price €	CONF. Unit/Box
Tubo rame Ø 15 - Copper pipe Ø 15 L = 300			
165 0367	14	17,63	5/40
165 0266	16	18,43	5/40
165 0368	18	18,84	5/40
165 0229	20	20,57	5/40
Tubo rame Ø 15 - Copper pipe Ø 15 L = 1100			
165 0369	14	33,48	5/40
165 0332	16	35,01	5/40
165 0370	18	33,48	5/40
165 0293	20	33,55	5/40



ART. 1674

Riduzione per tubo multistrato/
tubo rame a saldare
Reduction for multilayer pipe/
soldering copper pipe

CODICE Code	TIPO Size	PREZZO Price €	CONF. Unit/Box
165 0270	16 x 20 - Ø 15	3,16	10/100

RACCORDI A PRESSARE PER TUBO MULTISTRATO "AL-COBRAPEX"

PRESS-FITTINGS FOR MULTILAYER PIPE "AL-COBRAPEX"



ART. 1697

Valvola a sfera diritta con leva farfalla rossa e girello folle
Straight ball valve with red "T" handle and loose nut

CODICE Code	TIPO Size	PREZZO Price €	CONF. Unit/Box
168 0021	20 x 3/4"	13,19	20/80
168 0035	25 x 3/4"	15,36	20/80
168 0030	26 x 3/4"	15,36	20/80
168 0032	32 x 1"	26,80	10/40



ART. 1697CK

Valvola a sfera diritta con leva farfalla rossa, girello folle e valvola di non ritorno
Straight ball valve with red "T" handle, loose nut and check valve

CODICE Code	TIPO Size	PREZZO Price €	CONF. Unit/Box
168 0029	20 x 3/4"	14,97	20/80
168 0027	25 x 3/4"	17,15	20/80
168 0036	26 x 3/4"	17,15	20/80
168 0037	32 x 1"	30,36	10/40



ART. 1692

Valvola a sfera a squadra con leva farfalla rossa e girello folle
Angle ball valve with red "T" handle and loose nut

CODICE Code	TIPO Size	PREZZO Price €	CONF. Unit/Box
168 0019	20 x 3/4"	15,26	15/60
168 0028	25 x 3/4"	18,94	15/60
168 0020	26 x 3/4"	18,94	15/60
168 0034	32 x 1"	31,61	10/40



ART. 1692CK

Valvola a sfera a squadra con leva farfalla rossa, girello folle e valvola di non ritorno.
Angle ball valve with red "T" handle, loose nut and check valve

CODICE Code	TIPO Size	PREZZO Price €	CONF. Unit/Box
168 0026	20 x 3/4"	17,04	15/60
168 0018	25 x 3/4"	20,69	15/60
168 0031	26 x 3/4"	20,69	15/60
168 0022	32 x 1"	35,45	10/40



ART. 1691

Valvola a sfera con leva farfalla
Ball valve with T handle

CODICE Code	TIPO Size	PREZZO Price €	CONF. Unit/Box
168 0010	16 x 16	19,83	5/50
168 0007	20 x 20	19,83	5/50
168 0025	25 x 25	22,34	5/50
168 0008	26 x 26	22,34	5/50



ART. 1690U

Valvola a sfera da incasso con geometria a "U"
Built in ball valve "U" shape

CODICE Code	TIPO Size	PREZZO Price €	CONF. Unit/Box
168 0013	16 x 16	29,64	1/25
168 0011	20 x 20	31,68	1/25
168 0016	25 x 25	41,73	1/25
168 0033	26 x 26	41,73	1/25

Esempio di utilizzo
How to use

con Art. 2980CSET
with Art. 2960CSET

con Art. 2983CSET
with Art. 2963CSET

con Art. 2961CSET
with Art. 2961CSET

Art. 1690U
Art. 1690U

RACCORDI A PRESSARE PER TUBO MULTISTRATO "AL-COBRAPEX"

PRESS-FITTINGS FOR MULTILAYER PIPE "AL-COBRAPEX"



ART. 1696
Valvola con vitone da incasso 2 vie
vie
Built in 2 ways valve with screw

CODICE Code	TIPO Size	PREZZO Price €	CONF. Unit/Box
168 0012	16 x 16	27,67	5/50
168 0017	18 x 18	28,99	5/50
168 0014	20 x 20	27,67	5/50
168 0024	25 x 25	30,79	5/50
168 0023	26 x 26	30,79	5/50



ART. 1690
Valvola a sfera da incasso
Built in ball valve

CODICE Code	TIPO Size	PREZZO Price €	CONF. Unit/Box
168 0002	16 x 16	22,01	5/50
168 0004	18 x 18	22,13	5/50
168 0001	20 x 20	22,01	5/50
168 0009	25 x 25	24,69	5/50
168 0003	26 x 26	24,69	5/50



ART. 2963SET
Set maniglia e rosone per valvole ad incasso per art. 2960, 1690C, 1690U e 1696
Handle and rosette for built-in valve - for art. 2960 and 1690C, 1690U and 1696

CODICE Code	TIPO Size	PREZZO Price €	CONF. Unit/Box
295 0014		vedi cap. 1	10/40



ART. 2960SET
Set cappuccio e rosone per valvole ad incasso per art. 2960, 1690C, 1690U e 1696
Cap and rosette for built-in valve for art. 2960, 1690C, 1690U and 1696

CODICE Code	TIPO Size	PREZZO Price €	CONF. Unit/Box
295 0006		vedi cap. 1	12/48



ART. 2961SET
Set leva e rosone per valvole ad incasso per art. 2960, 1690C, 1690U e 1696
Handle and rosette for built-in valve - for art. 2960 and 1690C, 1690U and 1696

CODICE Code	TIPO Size	PREZZO Price €	CONF. Unit/Box
295 0009		vedi cap. 1	12/48



ART. 2960PR
Set prolunga per valvola ad incasso per art. 2960, 1690C, 1690U e 1696
Spindle extension for built-in valve for art. 2960, 1690C, 1690U and 1696

CODICE Code	TIPO Size	PREZZO Price €	CONF. Unit/Box
295 0015	1/2"	vedi cap. 1	10/200

con Art. 2960CSET
with Art. 2960CSET

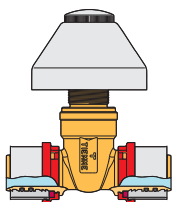

con Art. 2963CSET
with Art. 2963CSET

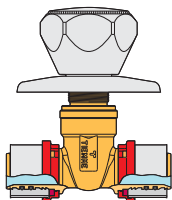

con Art. 2961CSET
with Art. 2961CSET

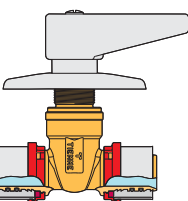

Esempio di utilizzo
How to use

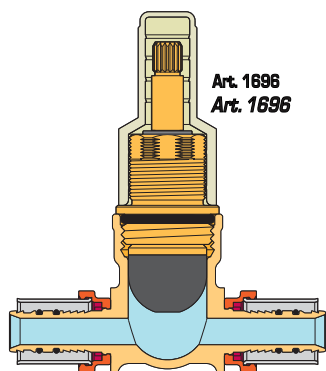

Art. 1696
Art. 1696

con Art. 2960CSET
with Art. 2960CSET

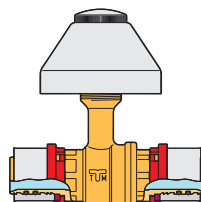

con Art. 2963CSET
with Art. 2963CSET

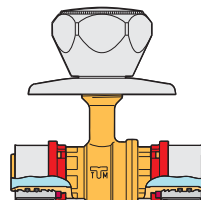

con Art. 2961CSET
with Art. 2961CSET

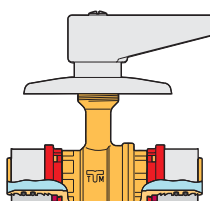

Esempio di utilizzo
How to use

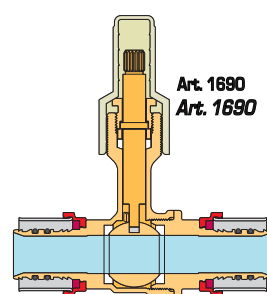

Art. 1690
Art. 1690

COMBIVALVE



ART. 1693
Valvola da incasso a 3 vie
Built in 3 ways valve

CODICE Code	TIPO Size	PREZZO Price €	CONF. Unit/Box
168 0005	20 x 16	37,35	1/20
168 0006	20 x 20	37,52	1/20
168 0015	26 x 20	38,30	1/20



ART. 1660
Raccordo curvo con giello su
attacchi 3/4"x18 (EUROCONO)
*Elbow with loose nut for 3/4"x18
connection (EUROCONUS)*

CODICE Code	TIPO Size	PREZZO Price €	CONF. Unit/Box
165 0182	16 x 3/4"	10,60	5/100
165 0173	20 x 3/4"	10,66	5/100



ART. 1879
Terminale con attacco 3/4"x18
(EUROCONO)
*End fitting with 3/4"x18 connection
(EUROCONUS)*

CODICE Code	TIPO Size	PREZZO Price €	CONF. Unit/Box
144 0071	3/4" x 18	vedi cap. 11	10/250



ART. 1493SET
Staffa di fissaggio completa di
viti
Fixing bracket with bolts

CODICE Code	TIPO Size	PREZZO Price €	CONF. Unit/Box
159 0034	unica - single	1,97	1/50

da utilizzare con art. 1693 / to be used with art. 1693

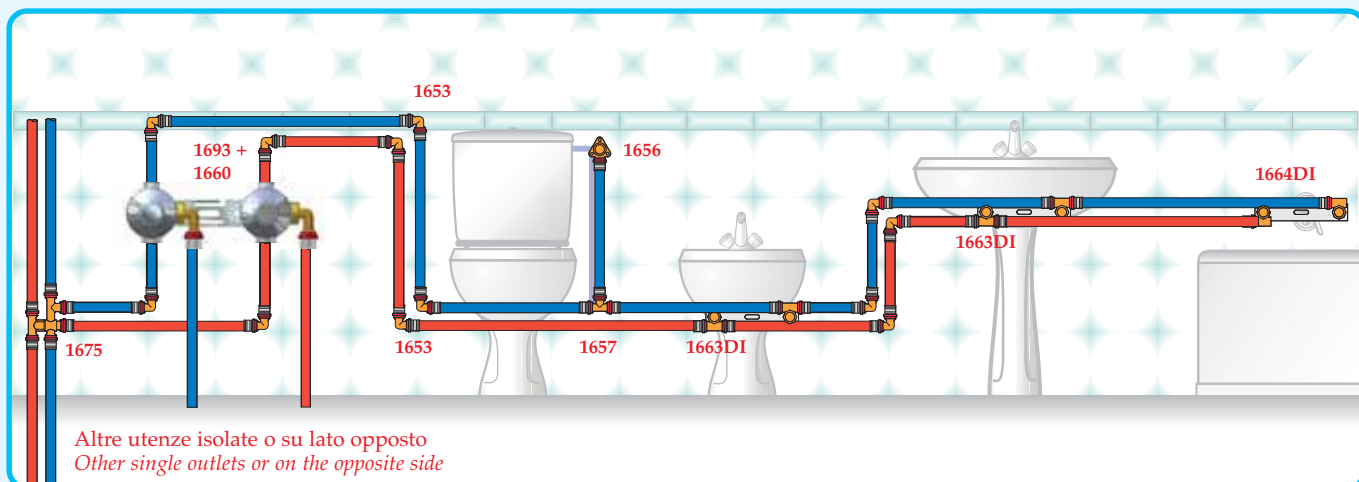



ART. 1650DR
Raccordo diritto maschio
Straight fitting male

CODICE Code	TIPO Size	PREZZO Price €	CONF. Unit/Box
167 0062	14 x 1/2"	5,57	10/100
167 0136	16 x 3/8"	3,74	10/100
167 0022	16 x 1/2"	2,95	10/100
167 0066	16 x 3/4"	5,41	10/100
167 0137	18 x 1/2"	3,92	10/100
167 0138	18 x 3/4"	5,56	10/100
167 0030	20 x 1/2"	3,55	10/100
167 0018	20 x 3/4"	4,63	10/100
167 0139	26 x 1/2"	7,25	10/50
167 0055	26 x 3/4"	6,76	10/50
167 0048	26 x 1"	10,79	5/25
167 0067	32 x 1"	12,38	5/25
167 0068	32 x 1"1/4	22,16	5/25
167 0050	40 x 1"1/4	20,13	5/25
167 0042	50 x 1"1/2	36,11	2/16
167 0069	63 x 2"	53,84	2/16



ART. 1651DR
Raccordo diritto doppio
Straight fitting double

CODICE Code	TIPO Size	PREZZO Price €	CONF. Unit/Box
167 0140	14 x 14	8,46	10/100
167 0015	16 x 16	4,57	10/100
167 0141	18 x 18	7,94	10/100
167 0014	20 x 20	5,94	10/100
167 0035	26 x 26	8,90	5/50
167 0033	32 x 32	15,39	5/25
167 0031	40 x 40	23,44	5/25
167 0046	50 x 50	44,61	2/16
167 0077	63 x 63	70,84	2/16
Raccordo diritto doppio ridotto - <i>Reduced straight fitting double</i>			
167 0142	16 x 14	7,81	10/100
167 0143	18 x 16	6,47	10/100
167 0007	20 x 16	6,21	10/100
167 0144	20 x 18	9,07	10/100
167 0052	26 x 16	9,89	10/100
167 0145	26 x 18	12,04	10/100
167 0071	26 x 20	11,43	10/100
167 0146	32 x 16	17,54	5/25
167 0065	32 x 20	15,84	5/25
167 0040	32 x 26	17,09	5/25
167 0072	40 x 26	24,10	5/25
167 0061	40 x 32	24,03	5/25
167 0073	50 x 32	41,44	2/16
167 0074	50 x 40	40,77	2/16
167 0075	63 x 40	66,93	2/16
167 0076	63 x 50	69,37	2/16



ART. 1651KBDR
Raccordo diritto doppio tubo
multistrato / rame a compressione
*Straight fitting double multilayer
pipe/compression copper pipe*

CODICE Code	TIPO Size	PREZZO Price €	CONF. Unit/Box
167 0011	16 x 2 - Ø 15	7,41	10/100
167 0010	20 x 2 - Ø 22	9,30	10/100
167 0037	26 x 3 - Ø 22	12,92	5/25
167 0024	26 x 3 - Ø 28	13,91	5/25



ART. 1651CYDR
Raccordo diritto tubo
multistrato / tubetto cilindrico
*Straight fitting multilayer pipe/
cylindrical pipe*

CODICE Code	TIPO Size	PREZZO Price €	CONF. Unit/Box
167 0070	16 x Ø 12	2,79	10/100
167 0001	16 x Ø 15	2,83	10/100
167 0008	20 x Ø 15	3,70	10/100
167 0002	20 x Ø 22	4,83	10/100
167 0003	26 x Ø 22	5,47	10/100
167 0004	26 x Ø 28	6,72	10/100



ART. 1652DR
Raccordo diritto femmina
Straight fitting female

CODICE Code	TIPO Size	PREZZO Price €	CONF. Unit/Box
167 0063	14 x 1/2"	5,52	10/100
167 0019	16 x 1/2"	3,52	10/100
167 0147	16 x 3/4"	8,14	10/100
167 0148	18 x 1/2"	6,33	10/100
167 0149	18 x 3/4"	8,62	10/100
167 0017	20 x 1/2"	4,83	10/100
167 0012	20 x 3/4"	6,22	10/100
167 0064	26 x 3/4"	8,48	5/25
167 0078	26 x 1"	12,26	5/25
167 0079	32 x 1"	13,82	5/25
167 0080	32 x 1"1/4	23,77	5/25
167 0081	40 x 1"1/4	22,69	5/25
167 0082	50 x 1"1/2	42,82	2/16



ART. 1653DR
Raccordo curvo doppio
Elbow double

CODICE Code	TIPO Size	PREZZO Price €	CONF. Unit/Box
167 0150	14 x 14	8,97	10/100
167 0013	16 x 16	5,40	10/100
167 0151	18 x 18	8,92	10/100
167 0083	20 x 20	6,96	10/100
167 0029	26 x 26	11,95	5/25
167 0026	32 x 32	17,50	5/25
167 0025	40 x 40	30,08	5/25
167 0027	50 x 50	77,78	2/8
167 0084	63 x 63	92,04	2/8



ART. 1654DR
Raccordo curvo maschio
Elbow male

CODICE Code	TIPO Size	PREZZO Price €	CONF. Unit/Box
167 0152	14 x 1/2"	8,38	10/100
167 0023	16 x 1/2"	7,11	10/100
167 0153	18 x 1/2"	8,35	10/100
167 0154	18 x 3/4"	12,38	10/100
167 0085	20 x 1/2"	7,79	10/100
167 0020	20 x 3/4"	8,79	10/50
167 0086	26 x 3/4"	10,77	5/50
167 0087	32 x 1"	19,65	5/25
167 0057	40 x 1"1/4"	34,69	5/25
167 0088	50 x 1"1/2"	67,21	2/8
167 0089	63 x 2"	78,50	2/8



ART. 1655DR
Raccordo curvo femmina
Elbow female

CODICE Code	TIPO Size	PREZZO Price €	CONF. Unit/Box
167 0155	14 x 1/2"	9,04	10/100
167 0038	16 x 1/2"	5,22	10/100
167 0156	18 x 1/2"	8,55	10/100
167 0157	18 x 3/4"	11,68	10/100
167 0060	20 x 1/2"	7,16	10/100
167 0090	20 x 3/4"	9,25	10/50
167 0091	26 x 3/4"	12,43	5/25
167 0158	26 x 1"	22,19	5/25
167 0044	32 x 1"	22,76	5/25
167 0092	40 x 1"1/4"	37,32	5/25
167 0093	50 x 1"1/2"	75,55	2/8



ART. 1656DR
Raccordo curvo femmina con
flangia a 3 fori
Wallplate elbow female 3 holes
H = 53 mm

CODICE Code	TIPO Size	PREZZO Price €	CONF. Unit/Box
167 0159	14 x 1/2"	9,75	10/50
167 0009	16 x 1/2"	6,98	10/50
167 0160	18 x 1/2"	9,89	10/50
167 0094	20 x 1/2"	9,04	5/50



ART. 1656SMDR
Raccordo curvo femmina con
flangia a 3 fori collo basso
Wallplate elbow female 3 holes
H = 40 mm

CODICE Code	TIPO Size	PREZZO Price €	CONF. Unit/Box
167 0161	14 x 1/2"	9,65	10/50
167 0162	16 x 1/2"	7,29	10/50
167 0095	20 x 1/2"	9,63	5/50



ART. 1661DR
Curva 45°
45° Elbow

CODICE Code	TIPO Size	PREZZO Price €	CONF. Unit/Box
167 0127	26 x 26	25,00	5/25
167 0163	32 x 32	28,27	5/25
167 0128	40 x 40	83,77	5/25
167 0129	50 x 50	91,14	1/10
167 0130	63 x 63	121,07	1/5



ART. 1676SMDR
Raccordo curvo femmina doppio
con flangia collo basso
Double wallplate elbow female
H = 40 mm

CODICE Code	TIPO Size	PREZZO Price €	CONF. Unit/Box
167 0164	14 x 1/2"	17,56	10/50
167 0165	16 x 1/2"	15,46	10/50
167 0166	20 x 1/2"	16,71	5/50



ART. 1657DR
Raccordo a T
Tee

CODICE Code	TIPO Size	PREZZO Price €	CONF. Unit/Box
167 0167	14 x 14 x 14	10,61	10/50
167 0006	16 x 16 x 16	7,06	10/50
167 0168	18 x 18 x 18	12,24	10/50
167 0016	20 x 20 x 20	8,83	5/50
167 0100	26 x 26 x 26	16,83	5/25
167 0104	32 x 32 x 32	27,22	5/25
167 0034	40 x 40 x 40	40,86	1/20
167 0109	50 x 50 x 50	73,01	1/10
167 0113	63 x 63 x 63	125,50	1/5
167 0169	16 x 14 x 14	12,16	10/50
167 0170	16 x 14 x 16	11,97	10/50
167 0049	16 x 20 x 16	11,56	5/50
167 0171	18 x 16 x 18	13,17	10/50
167 0051	20 x 16 x 16	10,70	5/50
167 0036	20 x 16 x 20	9,23	5/50
167 0172	20 x 18 x 18	14,86	5/50
167 0173	20 x 18 x 20	14,62	5/50
167 0045	20 x 20 x 16	11,67	5/50
167 0174	20 x 20 x 18	12,44	5/50
167 0096	20 x 26 x 20	19,99	5/25
167 0175	26 x 16 x 16	19,99	5/25
167 0032	26 x 16 x 20	17,04	5/25
167 0039	26 x 16 x 26	20,04	5/25
167 0176	26 x 18 x 26	20,75	5/25
167 0177	26 x 20 x 16	19,71	5/25
167 0097	26 x 20 x 20	19,59	5/25
167 0098	26 x 20 x 26	19,94	5/25
167 0178	26 x 26 x 16	20,34	5/25
167 0099	26 x 26 x 20	21,25	5/25
167 0179	26 x 32 x 26	30,05	5/25
167 0180	32 x 16 x 32	26,92	5/25
167 0181	32 x 20 x 20	26,63	5/25
167 0182	32 x 20 x 26	26,86	5/25



ART. 1662DR
Flangia per cassetta W.C. incasso
Wallplate elbow female for built-in WC

CODICE Code	TIPO Size	PREZZO Price €	CONF. Unit/Box
167 0201	16 x 1/2"	16,60	10/50
167 0202	18 x 1/2"	17,62	10/50
167 0203	20 x 1/2"	16,63	5/25

167 0101	32 x 20 x 32	25,80	5/25
167 0053	32 x 26 x 26	26,16	5/25
167 0102	32 x 26 x 32	25,90	5/25
167 0183	32 x 32 x 20	32,61	5/25
167 0103	32 x 32 x 26	30,66	5/25
167 0184	32 x 40 x 32	41,60	1/20
167 0185	40 x 16 x 40	45,47	1/20
167 0135	40 x 20 x 40	45,83	1/20
167 0186	40 x 26 x 40	46,81	1/20
167 0047	40 x 32 x 32	42,44	1/20
167 0041	40 x 32 x 40	41,44	1/20
167 0187	40 x 40 x 26	46,86	1/20
167 0105	40 x 40 x 32	46,24	1/20
167 0188	40 x 50 x 40	70,87	1/10
167 0189	50 x 16 x 50	63,70	1/10
167 0190	50 x 20 x 50	70,76	1/10
167 0106	50 x 26 x 50	66,33	1/10
167 0107	50 x 32 x 50	70,08	1/10
167 0191	50 x 40 x 40	74,11	1/10
167 0108	50 x 40 x 50	70,81	1/10
167 0192	50 x 50 x 32	81,08	1/10
167 0193	50 x 50 x 40	83,04	1/10
167 0194	63 x 26 x 63	129,06	1/5
167 0110	63 x 32 x 63	128,14	1/5
167 0111	63 x 40 x 63	129,14	1/5
167 0112	63 x 50 x 63	129,31	1/5



ART. 1658DR
T maschio
Tee male

CODICE Code	TIPO Size	PREZZO Price €	CONF. Unit/Box
167 0195	14 x 1/2" x 14	12,81	10/100
167 0114	16 x 1/2" x 16	11,09	10/100
167 0196	18 x 1/2" x 18	14,59	10/100
167 0197	18 x 3/4" x 18	14,86	10/100
167 0115	20 x 1/2" x 20	12,61	5/100
167 0116	20 x 3/4" x 20	13,64	5/50
167 0198	26 x 1/2" x 26	23,29	5/25
167 0117	26 x 3/4" x 26	22,76	5/25
167 0199	26 x 1" x 26	26,77	5/25
167 0118	32 x 1" x 32	28,34	5/25
167 0200	40 x 1" 1/4 x 40	45,54	1/20



ART. 1659DR
T femmina
Tee female

CODICE Code	TIPO Size	PREZZO Price €	CONF. Unit/Box
167 0204	14 x 1/2" x 14	14,29	10/100
167 0005	16 x 1/2" x 16	10,17	10/100
167 0205	18 x 1/2" x 18	12,17	10/100
167 0206	18 x 3/4" x 18	15,77	10/50
167 0119	20 x 1/2" x 20	11,19	5/50
167 0120	20 x 3/4" x 20	14,19	5/50
167 0121	26 x 1/2" x 26	23,23	5/25
167 0122	26 x 3/4" x 26	21,26	5/25
167 0058	32 x 1/2" x 32	33,34	5/25
167 0207	32 x 3/4" x 32	30,26	5/25
167 0123	32 x 1" x 32	30,75	5/25
167 0028	40 x 1" x 40	40,17	1/20
167 0124	40 x 1"1/4" x 40	44,31	1/20
167 0043	50 x 3/4" x 50	65,64	1/10
167 0125	50 x 1" x 50	67,57	1/10
167 0126	63 x 1" x 63	115,09	1/5



ART. 1665DR
Raccordo diritto con girello e guarnizione piana
Straight fitting with loose nut and flat washer

CODICE Code	TIPO Size	PREZZO Price €	CONF. Unit/Box
167 0131	16 x 3/8"	3,93	10/100
167 0021	16 x 1/2"	3,84	10/100
167 0054	20 x 1/2"	4,74	10/100



ART. 1666DR
Raccordo diritto con girello su attacchi 3/4"x18 (EUROCONO)
Straight fitting with loose nut for 3/4"x18 connections (EUROCONUS)

CODICE Code	TIPO Size	PREZZO Price €	CONF. Unit/Box
167 0208	14 x 3/4"	12,91	10/100
167 0209	16 x 3/4"	11,94	10/100
167 0210	18 x 3/4"	12,96	10/100
167 0211	20 x 3/4"	12,46	10/100



ART. 1668DR
Raccordo diritto con girello su attacchi 1/2"x16
Straight fitting with loose nut for 1/2"x16 connections

CODICE Code	TIPO Size	PREZZO Price €	CONF. Unit/Box
167 0212	14 x 1/2"	4,54	10/100
167 0213	16 x 1/2"	4,22	10/100
167 0214	18 x 1/2"	5,65	10/100
167 0215	20 x 1/2"	5,18	10/100

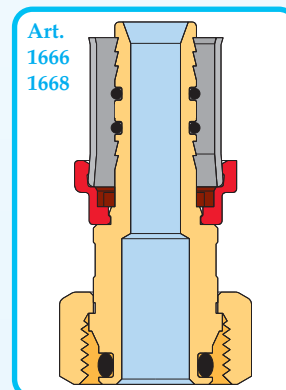
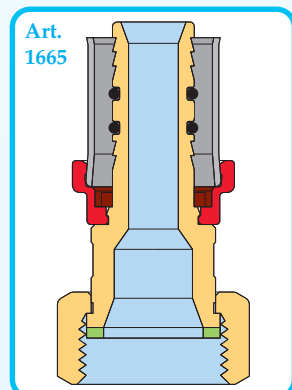

ART. 1677DR
Terminale
Stop end

CODICE Code	TIPO Size	PREZZO Price €	CONF. Unit/Box
167 0216	14	7,14	10/100
167 0056	16	7,11	10/100
167 0217	18	7,75	10/100
167 0059	20	8,49	10/100
167 0133	26	9,93	5/50
167 0218	32	11,60	5/50
167 0219	40	20,59	5/25



ART. 1669DR
Raccordo curvo maschio con girello
Elbow fitting male with loose nut connector

CODICE Code	TIPO Size	PREZZO Price €	CONF. Unit/Box
167 0132	26 x 1"	21,90	5/25

TUBO MULTISTRATO "AL-COBRAPEX" - PE-X/AL/PE-X

"AL-COBRAPEX" MULTILAYER PIPE



ART. 0600 - 0660

Tubo in polietilene reticolato con anima in alluminio - Colore Bianco
White rolls cross-linked polyethylene pipe with aluminium insert. In coils

CODICE Code	TIPO Size	ALLUM. Alum.	PREZZO Price €	CONF. Unit/Box
060 0024	14 x 2,0	0,30	vedi cap. 16	100 m/2800 m
060 0002	16 x 2,0	0,30	vedi cap. 16	100 m/2800 m
060 0018	18 x 2,0	0,35	vedi cap. 16	100 m/1800 m
060 0004	20 x 2,0	0,40	vedi cap. 16	100 m/1800 m
060 0013	26 x 3,0	0,65	vedi cap. 16	50 m/900 m
060 0011	32 x 3,0	0,85	vedi cap. 16	25 m/250 m
060 0021	14 x 2,0	0,20	vedi cap. 16	100 m/2800 m
060 0001	16 x 2,0	0,20	vedi cap. 16	100 m/2800 m
060 0016	18 x 2,0	0,25	vedi cap. 16	100 m/1800 m
060 0003	20 x 2,0	0,25	vedi cap. 16	100 m/1800 m
060 0019	25 x 2,5	0,30	vedi cap. 16	50 m/900 m
060 0007	26 x 3,0	0,30	vedi cap. 16	50 m/900 m
060 0014	32 x 3,0	0,50	vedi cap. 16	25 m/250 m



ART. 0600

Tubo in polietilene reticolato con anima in alluminio - Colore Bianco.
In barre.
White bars cross-linked polyethylene pipe with aluminium insert. In lengths

CODICE Code	TIPO Size	ALLUM. Alum.	PREZZO Price €	CONF. Unit/Box
060 0020	16 x 2,0	0,30	vedi cap. 16	4 m x 15 pz= 60 m
060 0030	18 x 2,0	0,35	vedi cap. 16	4 m x 10 pz= 40 m
060 0017	20 x 2,0	0,40	vedi cap. 16	4 m x 10 pz= 40 m
060 0012	26 x 3,0	0,65	vedi cap. 16	4 m x 10 pz= 40 m
060 0006	32 x 3,0	0,85	vedi cap. 16	4 m x 10 pz= 40 m
060 0005	40 x 3,5	1,00	vedi cap. 16	4 m x 5 pz= 20 m
060 0009	50 x 4,0	1,20	vedi cap. 16	4 m x 5 pz= 20 m
060 0008	63 x 4,5	1,50	vedi cap. 16	4 m x 3 pz= 12 m
060 0047	14 x 2,0	0,20	vedi cap. 16	4 m x 15 pz= 60 m
060 0026	16 x 2,0	0,20	vedi cap. 16	4 m x 60 pz= 240 m
060 0035	18 x 2,0	0,25	vedi cap. 16	4 m x 40 pz= 160 m
060 0023	20 x 2,0	0,25	vedi cap. 16	4 m x 40 pz= 160 m
060 0027	25 x 2,5	0,30	vedi cap. 16	4 m x 20 pz= 80 m
060 0025	26 x 3,0	0,30	vedi cap. 16	4 m x 20 pz= 80 m
060 0022	32 x 3,0	0,50	vedi cap. 16	4 m x 15 pz= 60 m



ART. 0630B

Tubo multistrato rivestito blu isolato
Multilayer insulated pipe with blue sheath

CODICE Code	TIPO Size	ALLUM. Alum.	PREZZO Price €	CONF. Unit/Box
062 0018	14 x 2,0	0,20	vedi cap. 16	50 m/700 m
062 0004	16 x 2,0	0,20	vedi cap. 16	50 m/700 m
062 0014	16 x 2,0	0,20	vedi cap. 16	100 m/1300 m
062 0021	18 x 2,0	0,25	vedi cap. 16	50 m/650 m
062 0006	20 x 2,0	0,25	vedi cap. 16	50 m/700 m
062 0026	25 x 2,5	0,30	vedi cap. 16	50 m/500 m
062 0005	26 x 3,0	0,30	vedi cap. 16	50 m/500 m
062 0022	32 x 3,0	0,50	vedi cap. 16	25 m/250 m



ART. 0630R

Tubo multistrato rivestito rosso isolato
Multilayer insulated pipe with red sheath

CODICE Code	TIPO Size	ALLUM. Alum.	PREZZO Price €	CONF. Unit/Box
062 0012	14 x 2,0	0,20	vedi cap. 16	50 m/700 m
062 0001	16 x 2,0	0,20	vedi cap. 16	50 m/700 m
062 0009	16 x 2,0	0,20	vedi cap. 16	100 m/1300 m
062 0017	18 x 2,0	0,25	vedi cap. 16	50 m/650 m
062 0003	20 x 2,0	0,25	vedi cap. 16	50 m/700 m
062 0025	25 x 2,5	0,30	vedi cap. 16	50 m/500 m
062 0002	26 x 3,0	0,30	vedi cap. 16	50 m/500 m
062 0010	32 x 3,0	0,50	vedi cap. 16	25 m/250 m



ART. 0670B

Tubo multistrato rivestito blu isolato
Multilayer insulated pipe with blue sheath

CODICE Code	TIPO Size	ALLUM. Alum.	PREZZO Price €	CONF. Unit/Box
062 0013	16 x 2,0	0,30	vedi cap. 16	50 m/700 m
062 0024	18 x 2,0	0,35	vedi cap. 16	50 m/650 m
062 0016	20 x 2,0	0,40	vedi cap. 16	50 m/700 m



ART. 0670R

Tubo multistrato rivestito rosso isolato
Multilayer insulated pipe with red sheath

CODICE Code	TIPO Size	ALLUM. Alum.	PREZZO Price €	CONF. Unit/Box
062 0007	16 x 2,0	0,30	vedi cap. 16	50 m/700 m
062 0023	18 x 2,0	0,35	vedi cap. 16	50 m/650 m
062 0011	20 x 2,0	0,40	vedi cap. 16	50 m/700 m

TUBO MULTISTRATO "AL-COBRAPEX" - PE-X/AL/PE-X

"AL-COBRAPEX" MULTILAYER PIPE



ART. 0615B

Tubo multistrato rivestito bianco isolato
Multilayer insulated pipe with white sheath

CODICE Code	TIPO Size	ALLUM. Alum.	PREZZO Price €	CONF. Unit/Box
062 0020	16 x 2,0	0,40	vedi cap. 16	50 m/700 m



ART. 0635

Tubo multistrato rivestito verde per raffreddamento
Multilayer pipe with green sheath for cooling systems

CODICE Code	TIPO Size	ALLUM. Alum.	PREZZO Price €	CONF. Unit/Box
062 0019	16 x 2,0	0,20	vedi cap. 16	50 m/500 m
062 0027	18 x 2,0	0,25	vedi cap. 16	50 m/450 m
062 0008	20 x 2,0	0,25	vedi cap. 16	50 m/450 m
062 0015	26 x 3,0	0,30	vedi cap. 16	25 m/250 m



ART. 0640B

Tubo multistrato con guaina corrugata blu
Multilayer pipe with corrugated blue sheath

CODICE Code	TIPO Size	ALLUM. Alum.	PREZZO Price €	CONF. Unit/Box
064 0009	14 x 2,0	0,20	vedi cap. 16	50 m/900 m
064 0001	16 x 2,0	0,20	vedi cap. 16	50 m/1350 m
064 0004	16 x 2,0	0,20	vedi cap. 16	100m/1000m
064 0007	18 x 2,0	0,25	vedi cap. 16	50 m/900 m
064 0003	20 x 2,0	0,25	vedi cap. 16	50 m/1350 m



ART. 0640R

Tubo multistrato con guaina corrugata rossa
Multilayer pipe with corrugated red sheath

CODICE Code	TIPO Size	ALLUM. Alum.	PREZZO Price €	CONF. Unit/Box
064 0010	14 x 2,0	0,20	vedi cap. 16	50 m/900 m
064 0002	16 x 2,0	0,20	vedi cap. 16	50 m/1350 m
064 0005	16 x 2,0	0,20	vedi cap. 16	100 m/1000 m
064 0008	18 x 2,0	0,25	vedi cap. 16	50 m/900 m
064 0006	20 x 2,0	0,25	vedi cap. 16	50 m/1350 m



ART. 0625

Calza P.V.C. trasparente CL 1 di tenuta
Transparent P.V.C. seal

CODICE Code	TIPO Size	PREZZO Price €	CONF. Unit/Box
060 0034	12	vedi cap. 16	10/250
060 0046	14	vedi cap. 16	10/250
060 0036	16	vedi cap. 16	10/250
060 0038	18	vedi cap. 16	10/250
060 0037	20	vedi cap. 16	10/250



ART. 0900B

Guaina corrugata blu per la protezione del tubo
Corrugated blue sheath for protection of the pipe

CODICE Code	TIPO Size	PREZZO Price €/m	CONF. Unit/Box
090 0004	L=100 m Ø int.=20 mm	vedi cap. 16	100/1000 m
090 0010	L=50 m Ø int.=23 mm	vedi cap. 19	50/1000 m
090 0003	L=100 m Ø int.=23 mm	vedi cap. 16	100/1000 m
090 0008	L=50 m Ø int.=28 mm	vedi cap. 16	50/500 m



ART. 0900R

Guaina corrugata rossa per la protezione del tubo
Corrugated red sheath for protection of the pipe

CODICE Code	TIPO Size	PREZZO Price €/m	CONF. Unit/Box
090 0005	L=100 m Ø int.=20 mm	vedi cap. 16	100/1000 m
090 0001	L=50 m Ø int.=23 mm	vedi cap. 19	50/1000 m
090 0002	L=100 m Ø int.=23 mm	vedi cap. 16	100/1000 m
090 0007	L=50 m Ø int.=28 mm	vedi cap. 16	50/500 m

Raccordi Multi-pinza

Multi-jaws connection system now

Studiato e testato per essere utilizzato indifferentemente con 7 profili diversi:

TIEMME, TH, U, H, F, B, RF.

Designed and tested for easy use with 7 different clamping profiles:

TIEMME, TH, U, H, F, B, RF.

