



10



10

TIEMME

www.tiemme.com

COPYRIGHT

serie 1500

**RACCORDI
GENERICI IN
OTTONE**

BRASS FITTINGS

RACCORDI GENERICI IN OTTONE

BRASS FITTINGS



ART. 1500
Portagomma tipo Roma con filetto maschio
"Roma" male hose connection

CODICE Code	TIPO Size	PREZZO Price €	CONF. Unit/Box
150 0160	15 x 1/2"	2,02	10/300
150 0189	20 x 1/2"	1,60	10/250
150 0116	20 x 3/4"	2,44	10/200
150 0192	25 x 3/4"	3,69	10/150
150 0129	25 x 1"	3,58	10/100
150 0223	30 x 1"	4,60	10/80
150 0241	35 x 1"1/4	5,74	5/50
150 0239	40 x 1"1/2	8,18	5/40
150 0417	45 x 1"1/2	13,58	5/35
150 0215	50 x 2"	14,39	2/20
150 0473*	6 x 1/4"	1,12	25/1000
150 0568*	8 x 1/4"	1,19	25/1000
150 0507*	10 x 1/4"	1,35	25/1000
150 0479*	10 x 3/8"	1,09	25/600
150 0522*	12 x 3/8"	1,27	25/600
150 0326*	12 x 1/2"	1,41	10/350
150 0547*	14 x 3/8"	1,21	10/400
150 0418*	14 x 1/2"	1,47	10/300

*A richiesta disponibile in versione nichelata
Nickel-plated version available on request



ART. 1501
Portagomma tipo Roma con filetto femmina
"Roma" female hose connection

CODICE Code	TIPO Size	PREZZO Price €	CONF. Unit/Box
150 0592	10 x 1/4"	2,13	25/600
150 0454	10 x 3/8"	2,29	25/600
150 0293	10 x 1/2"	2,00	25/500
150 0387	13 x 1/2"	2,29	25/400
150 0280	15 x 1/2"	2,26	10/300
150 0365	18 x 1/2"	2,08	10/300
150 0263	20 x 3/4"	2,95	10/200
150 0289	25 x 1"	4,94	10/100
150 0423	30 x 1"	5,41	10/80
150 0498	30 x 1"1/4	7,43	5/80
150 0496	35 x 1"1/4	7,57	5/75



ART. 1509
Raccordo 3/4" 5 vie con 2
attacchi 1/4"
5 ways 3/4" fittings with two 1/4"
connection

CODICE Code	TIPO Size	PREZZO Price €	CONF. Unit/Box
150 0416	3/4"	6,24	5/50



ART. 1510
Raccordo a 5 vie
5 ways connector

CODICE Code	TIPO Size	PREZZO Price €	CONF. Unit/Box
150 0128	72 x 1"	7,89	5/40
150 0163	82 x 1"	8,82	5/40
150 0132	92 x 1"	9,37	5/35



ART. 1511
Raccordo a 3 vie
3 ways connector

CODICE Code	TIPO Size	PREZZO Price €	CONF. Unit/Box
150 0147	72 x 1"	6,91	5/50



ART. 1512
Prolunga
Extension

CODICE Code	TIPO Size	PREZZO Price €	CONF. Unit/Box
150 0315	44 x 1"	7,66	5/75



ART. 1513
Niplo disassato di
15 mm maschio/femmina
M/F disaligned nipple (15 mm)

CODICE Code	TIPO Size	PREZZO Price €	CONF. Unit/Box
150 0444	1"	18,04	5/50



ART. 1514
Niplo disassato di
25 mm maschio/
femmina
M/F disaligned nipple
(25 mm)

CODICE Code	TIPO Size	PREZZO Price €	CONF. Unit/Box
150 0672	1"	24,66	2/40

RACCORDI GENERICI IN OTTONE

BRASS FITTINGS



ART. 1522
Cannotto con dado girevole
Tail with loose nut

CODICE Code	TIPO Size	PREZZO Price €	CONF. Unit/Box
150 0035	3/4" x 1/2"	4,38	1/80
150 0042	1" x 3/4"	7,49	1/40
150 0062	1"1/4 x 1"	13,97	1/20
150 0094	1"1/2 x 1"1/4	23,33	1/15
150 0072	2" x 1"1/2	32,63	1/10
150 0101	2"1/2 x 2"	51,54	1/5

Il set comprende: 2 cannotti, 2 dadi girevoli, 2 guarnizioni
The set include: 2 tails, 2 nuts and 2 gaskets



ART. 1530
Prolunga filettata
maschio / femmina da barra
Extension male/female

CODICE Code	L x G → F	PREZZO Price €	CONF. Unit/Box
150 0413	10 x 3/8" 3/8"	1,14	10/500
150 0482	15 x 3/8" 3/8"	1,24	10/450
150 0422	20 x 3/8" 3/8"	1,42	10/300
150 0471	30 x 3/8" 3/8"	2,29	10/250
150 0528	40 x 3/8" 3/8"	2,70	10/200
150 0497	50 x 3/8" 3/8"	3,33	10/200
150 0026	10 x 1/2" 1/2"	1,17	10/350
150 0031	15 x 1/2" 1/2"	1,32	10/300
150 0024	20 x 1/2" 1/2"	1,66	10/250
150 0100	25 x 1/2" 1/2"	2,02	10/200
150 0038	30 x 1/2" 1/2"	2,22	10/200
150 0079	40 x 1/2" 1/2"	3,19	5/120
150 0045	50 x 1/2" 1/2"	3,89	5/120
150 0145	80 x 1/2" 1/2"	5,03	5/80
150 0104	100 x 1/2" 1/2"	6,19	5/70
150 0333	150 x 1/2" 1/2"	17,01	5/50
150 0217	10 x 3/4" 3/4"	1,83	10/200
150 0211	15 x 3/4" 3/4"	2,08	10/200
150 0142	20 x 3/4" 3/4"	2,43	10/180
150 0301	25 x 3/4" 3/4"	3,29	10/180
150 0143	30 x 3/4" 3/4"	3,17	5/100
150 0236	40 x 3/4" 3/4"	4,97	5/100
150 0161	50 x 3/4" 3/4"	6,76	5/80
150 0321	80 x 3/4" 3/4"	7,79	5/50
150 0284	100 x 3/4" 3/4"	9,44	5/40
150 0390	10 x 1" 1"	3,74	10/150
150 0404	15 x 1" 1"	4,31	10/130
150 0268	20 x 1" 1"	4,37	10/120
150 0314	25 x 1" 1"	7,47	5/90
150 0256	30 x 1" 1"	7,83	5/80
150 0369	40 x 1" 1"	9,24	5/70
150 0245	50 x 1" 1"	10,13	5/60



ART. 1530C
Prolunga cromata filettata
maschio / femmina da barra
Chrome-plated extension male/female

CODICE Code	L x G → F	PREZZO Price €	CONF. Unit/Box
150 0449	10 x 3/8" 3/8"	1,46	10/500
150 0458	15 x 3/8" 3/8"	1,46	10/450
150 0437	20 x 3/8" 3/8"	1,68	10/300
150 0442	30 x 3/8" 3/8"	2,65	10/250
150 0534	40 x 3/8" 3/8"	3,01	10/200
150 0519	50 x 3/8" 3/8"	3,65	10/200
150 0055	10 x 1/2" 1/2"	1,63	10/350
150 0069	15 x 1/2" 1/2"	1,86	10/300
150 0060	20 x 1/2" 1/2"	2,00	10/250
150 0170	25 x 1/2" 1/2"	2,59	10/200
150 0071	30 x 1/2" 1/2"	2,65	10/200
150 0113	40 x 1/2" 1/2"	3,83	5/120
150 0052	50 x 1/2" 1/2"	4,34	5/120
150 0184	80 x 1/2" 1/2"	6,08	5/80
150 0188	100 x 1/2" 1/2"	7,47	5/70
150 0402	150 x 1/2" 1/2"	20,42	5/50
150 0335	10 x 3/4" 3/4"	2,19	10/200
150 0317	15 x 3/4" 3/4"	2,82	10/200
150 0269	20 x 3/4" 3/4"	2,93	10/180
150 0348	25 x 3/4" 3/4"	3,94	10/180
150 0240	30 x 3/4" 3/4"	3,76	5/100
150 0252	40 x 3/4" 3/4"	5,47	5/100
150 0139	50 x 3/4" 3/4"	7,44	5/80
150 0313	80 x 3/4" 3/4"	8,51	5/50
150 0309	100 x 3/4" 3/4"	10,03	5/40
150 0504	10 x 1" 1"	5,06	10/150
150 0521	15 x 1" 1"	5,17	10/130
150 0425	20 x 1" 1"	5,69	10/120
150 0491	25 x 1" 1"	9,69	5/90
150 0405	30 x 1" 1"	10,38	5/80
150 0393	40 x 1" 1"	11,59	5/70
150 0328	50 x 1" 1"	12,51	5/60

ART. 1530

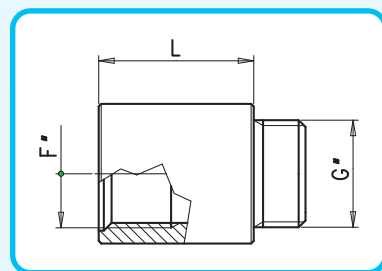

RACCORDI GENERICI IN OTTONE

BRASS FITTINGS



ART. 1540

Barilotto maschio / maschio
Male connector

CODICE Code	TIPO Size	PREZZO Price €	CONF. Unit/Box
150 0198	1/2" x 50	1,66	1/50
150 0235	1/2" x 60	2,08	1/45
150 0312	1/2" x 70	2,32	1/40
150 0232	1/2" x 80	2,67	1/35
150 0311	1/2" x 90	3,18	1/30
150 0115	1/2" x 100	3,57	1/30
150 0155	1/2" x 150	5,63	1/15
150 0167	1/2" x 200	7,91	1/15
150 0274	1/2" x 250	10,23	1/15
150 0221	3/4" x 50	3,01	1/30
150 0246	3/4" x 60	3,62	1/30
150 0346	3/4" x 70	4,08	1/30
150 0212	3/4" x 80	4,46	1/20
150 0419	3/4" x 90	4,92	1/20
150 0112	3/4" x 100	5,51	1/20
150 0687	3/4" x 110	6,59	1/15
150 0152	3/4" x 150	9,40	1/10
150 0187	3/4" x 200	11,71	1/10
150 0300	3/4" x 250	16,08	1/8
150 0278	1" x 50	3,86	1/20
150 0255	1" x 60	4,37	1/20
150 0325	1" x 70	5,50	1/15
150 0302	1" x 80	5,93	1/15
150 0373	1" x 90	7,04	1/12
150 0126	1" x 100	7,38	1/12
150 0480	1" x 125	12,15	1/6
150 0560	1" x 130	7,48	1/6
150 0123	1" x 150	12,36	1/6
150 0159	1" x 200	15,75	1/6
150 0276	1" x 250	20,17	1/6
150 0626	1"1/4 x 50	4,73	1/20
150 0612	1"1/4 x 60	5,76	1/15
150 0631	1"1/4 x 70	7,50	1/15
150 0603	1"1/4 x 80	7,99	1/12
150 0632	1"1/4 x 90	9,52	1/12
150 0563	1"1/4 x 100	9,64	1/12
150 0629	1"1/4 x 125	12,72	1/6
150 0633	1"1/4 x 130	13,35	1/6
150 0584	1"1/4 x 150	15,80	1/6
150 0294	1"1/4 x 170	18,49	1/6
150 0516	1"1/4 x 200	20,98	1/6
150 0614	1"1/4 x 250	28,11	1/3



ART. 1541

Barilotto scorrevole
Connector - male threaded

CODICE Code	TIPO Size	PREZZO Price €	CONF. Unit/Box
150 0286	1/2" x 100	3,50	1/30
150 0260	1/2" x 150	5,82	1/15
150 0343	1/2" x 200	7,88	1/15
150 0271	3/4" x 100	5,64	1/20
150 0257	3/4" x 150	9,81	1/10
150 0338	3/4" x 200	12,09	1/10
150 0254	1" x 100	7,76	1/12
150 0307	1" x 150	12,36	1/6
150 0350	1" x 200	16,63	1/6
150 0378	1" x 250	28,01	1/6



ART. 1543

Barra da 3 m
3 m bars

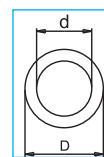

CODICE Code	TIPO Size	D	d	PREZZO Price €/m	CONF. Unit/Box
150 0344	1/2"	21	15	39,86	-
150 0382	3/4"	27	21	56,79	-
150 0385	1"	33	26	79,34	-



ART. 1550

Diritto femmina / femmina
Straight female connector

CODICE Code	TIPO Size	PREZZO Price €	CONF. Unit/Box
150 0692	1/4" x 1/4"	1,30	10/100
150 0319	3/8" x 3/8"	1,77	10/100
150 0288	1/2" x 3/8"	1,35	10/100
150 0034	1/2" x 1/2"	1,46	10/100
150 0046	3/4" x 1/2"	1,93	10/100
150 0047	3/4" x 3/4"	1,85	10/100
150 0080	1" x 1/2"	3,78	10/100
150 0059	1" x 3/4"	3,55	10/100
150 0032	1" x 1"	3,94	5/50
150 0110	1"1/4 x 1"	6,68	5/50
150 0122	1"1/4 x 1"1/4	5,98	5/50
150 0131	1"1/2 x 1"1/2	9,83	2/40
150 0135	2" x 2"	16,36	2/20
150 0386	2"1/2 x 2"1/2	34,97	1/10
150 0436	3" x 3"	47,18	1/5
150 0511	4" x 4"	86,51	1/5

RACCORDI GENERICI IN OTTONE

BRASS FITTINGS



ART. 1550N

Diritto femmina / femmina
nichelato
Nickel-plated straight female
connector

CODICE Code	TIPO Size	PREZZO Price €	CONF. Unit/Box
150 0461	3/8" x 3/8"	2,04	10/400
150 0453	1/2" x 3/8"	1,45	10/350
150 0136	1/2" x 1/2"	1,60	10/250
150 0193	3/4" x 1/2"	2,10	10/200
150 0150	3/4" x 3/4"	2,02	10/150
150 0178	1" x 3/4"	3,73	10/130
150 0154	1" x 1"	4,52	5/70
150 0376	1"1/4 x 1"	7,34	5/50
150 0399	1"1/4 x 1"1/4	6,59	5/60
150 0426	1"1/2 x 1"1/2	10,64	5/40
150 0478	2" x 2"	17,23	2/20
150 0599	2"1/2 x 2"1/2	40,19	1/10
150 0623	3" x 3"	54,23	1/5
150 0608	4" x 4"	99,54	1



ART. 1550C

Diritto femmina / femmina
cromato
Chrome-plated straight female
connector

CODICE Code	TIPO Size	PREZZO Price €	CONF. Unit/Box
150 0573	3/8" x 3/8"	2,26	10/400
150 0434	1/2" x 1/2"	1,84	10/250
150 0542	3/4" x 3/4"	2,20	10/150
150 0439	1" x 1/2"	4,54	10/150
150 0594	1" x 1"	4,73	5/70



ART. 1551

Diritto maschio / femmina
Straight fitting M/F connector

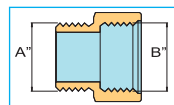

CODICE Code	TIPO Size	PREZZO Price €	CONF. Unit/Box
	A x B		
150 0529	3/8" x 3/8"	1,27	10/100
150 0106	3/8" x 1/2"	1,21	10/100
150 0581	3/8" x 1"	3,98	10/100
150 0305	1/2" x 3/8"	1,12	10/100
150 0259	1/2" x 1/2"	1,30	10/100
150 0043	1/2" x 3/4"	1,70	10/100
150 0158	1/2" x 1"	3,14	10/100
150 0628	24 (19 Fil) x 1/2"	1,72	10/100
150 0636	24 (19 Fil) x 24 (19 Fil)	2,10	10/100
150 0140	3/4" x 1/2"	1,69	10/100
150 0185	3/4" x 3/4"	2,20	10/100
150 0053	3/4" x 1"	2,82	10/100
150 0165	1" x 3/4"	3,57	10/100
150 0272	1" x 1"	3,03	10/100



ART. 1551N

Diritto maschio / femmina
nichelato
Nickel-plated straight fitting M/F
connector

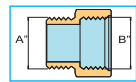

CODICE Code	TIPO Size	PREZZO Price €	CONF. Unit/Box
	A x B		
150 0606	3/8" x 3/8"	1,40	10/500
150 0174	3/8" x 1/2"	1,33	10/300
150 0607	3/8" x 1"	4,57	10/150
150 0415	1/2" x 3/8"	1,23	10/300
150 0477	1/2" x 1/2"	1,42	10/300
150 0127	1/2" x 3/4"	1,89	10/200
150 0249	1/2" x 1"	3,24	10/150
150 0364	3/4" x 1/2"	1,80	10/250
150 0456	3/4" x 3/4"	2,36	10/200
150 0202	3/4" x 1"	3,03	10/130
150 0366	1" x 3/4"	3,83	10/120
150 0493	1" x 1"	3,23	10/120



ART. 1220

Prolunga filettata
maschio / femmina
Extension male/female

Disponibile anche in versione cromata
Chrome-plated version available

CODICE Code	TIPO Size	PREZZO Price €	CONF. Unit/Box
150 0156	1/2" x 10 mm	1,01	25/400
150 0183	1/2" x 15 mm	1,28	25/350
150 0204	1/2" x 20 mm	1,68	10/300
150 0361	1/2" x 25 mm	2,10	10/250
150 0292	1/2" x 30 mm	2,19	10/200



ART. 1551C

Diritto maschio / femmina
cromato
Chrome-plated straight fitting M/F
connector

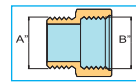

CODICE Code	TIPO Size	PREZZO Price €	CONF. Unit/Box
	A x B		
150 0459	3/8" x 1/2"	1,51	10/300
150 0571	1/2" x 3/8"	1,50	10/300
150 0484	1/2" x 3/4"	2,09	10/200
150 0582	1/2" x 1"	3,77	10/150
150 0634	24 (19 Fil) x 1/2"	2,24	10/250
150 0635	24 (19 Fil) x 24 (19 Fil)	2,71	10/200
150 0505	3/4" x 1/2"	2,07	10/250
150 0474	3/4" x 1"	3,38	10/130
150 0566	1" x 3/4"	3,68	10/120

RACCORDI GENERICI IN OTTONE

BRASS FITTINGS



ART. 1552

Dritto maschio / maschio
Straight fitting male connector

CODICE Code	TIPO Size	PREZZO Price €	CONF. Unit/Box
150 0354	1/4" x 1/4"	0,66	10/100
150 0306	3/8" x 1/4"	0,81	10/100
150 0218	3/8" x 3/8"	0,69	10/100
150 0395	1/2" x 1/4"	1,16	10/100
150 0074	1/2" x 3/8"	0,86	10/100
150 0002	1/2" x 1/2"	0,87	10/100
150 0012	3/4" x 1/2"	1,39	10/100
150 0008	3/4" x 3/4"	1,48	10/100
150 0089	1" x 1/2"	2,56	5/100
150 0022	1" x 3/4"	2,76	5/100
150 0001	1" x 1"	2,49	5/100
150 0044	1"1/4 x 1"	4,98	5/50
150 0025	1"1/4 x 1"1/4	5,40	5/50
150 0097	1"1/2 x 1"1/4	8,34	5/50
150 0088	1"1/2 x 1"1/2	7,16	5/25
150 0164	2" x 1"1/2	16,12	2/30
150 0081	2" x 2"	13,75	2/20
150 0486	2"1/2 x 1"1/2	25,15	2/20
150 0279	2"1/2 x 2"1/2	27,50	2/10
150 0375	3" x 3"	41,52	1/5
150 0487	4" x 4"	64,45	1/5

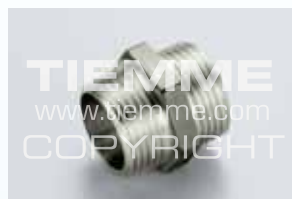

ART. 1552N

Dritto maschio / maschio
nichelato
Nickel-plated straight fitting male
connector

CODICE Code	TIPO Size	PREZZO Price €	CONF. Unit/Box
150 0597	1/8" x 1/8"	0,87	10/400
150 0536	1/4" x 1/4"	0,72	10/400
150 0576	3/8" x 1/8"	1,21	10/400
150 0550	3/8" x 1/4"	0,93	10/400
150 0432	3/8" x 3/8"	0,94	10/400
150 0196	1/2" x 3/8"	0,98	10/350
150 0036	1/2" x 1/2"	1,02	10/300
150 0124	3/4" x 1/2"	1,54	10/250
150 0084	3/4" x 3/4"	1,63	10/200
150 0205	1" x 1/2"	2,83	5/130
150 0157	1" x 3/4"	2,96	5/130
150 0070	1" x 1"	2,82	5/100
150 0318	1"1/4 x 1"	5,46	5/90
150 0207	1"1/4 x 1"1/4	5,93	5/50
150 0396	1"1/2 x 1"1/4	9,18	5/50
150 0267	1"1/2 x 1"1/2	8,14	5/40
150 0228	2" x 1"1/2	17,70	2/30
150 0429	2" x 2"	15,49	2/20
150 0616	2"1/2 x 1"1/2	28,91	2/20
150 0574	2"1/2 x 2"1/2	31,61	2/12
150 0621	3" x 3"	47,76	1/10
150 0617	4" x 4"	74,11	1/5



ART. 1552FD

Nippolo filettatura maschio con
sede piana per tubo acciaio
corrugato con guarnizione piana
Nipple male with flat seat for
corrugated steel pipe with flat
washer

CODICE Code	TIPO Size	PREZZO Price €	CONF. Unit/Box
471 0052	3/8" x 3/8"	vedi cap. 22	25/100
471 0030	1/2" x 1/2"	vedi cap. 22	10/100
471 0003	3/4" x 3/4"	vedi cap. 22	10/100
471 0017	1" x 1"	vedi cap. 22	5/100
471 0019	3/4" x 1/2"	vedi cap. 22	10/100
471 0005	1" x 3/4"	vedi cap. 22	5/100
471 0035	1" 1/4 x 1"	vedi cap. 22	5/50
471 0039	1" 1/2 x 1" 1/4	vedi cap. 22	5/50
471 0056	2" x 1" 1/2	vedi cap. 22	2/30



ART. 1553FD

Raccordo dritto di transizione tubo
rame / tubo acciaio corrugato
Straight fitting copper pipe/corrugated
steel pipe

CODICE Code	TIPO Size	PREZZO Price €	CONF. Unit/Box
471 0057	Ø 15 - 3/4"	vedi cap. 22	5/100
471 0016	Ø 22 - 3/4"	vedi cap. 22	5/100
471 0036	Ø 22 - 1"	vedi cap. 22	5/100



ART. 1551FD

Dritto maschio / femmina con sede
piana per tubo acciaio corrugato con
guarnizione piana.
Straight male/female with
flat seat for corrugated
steel pipe with flat washer

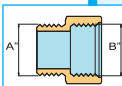

CODICE Code	TIPO Size	PREZZO Price €	CONF. Unit/Box
471 0078	3/4" x 1"	vedi cap. 22	10/100

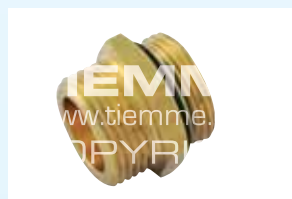

ART. 1552FDR

Dritto maschio / maschio con
battuta piana da una parte e tenuta
O-ring dall'altra.
Straight male with flat seat/O-ring

CODICE Code	TIPO Size	PREZZO Price €	CONF. Unit/Box
471 0004	3/4" x 3/4" OR	vedi cap. 22	10/100
471 0046	1" x 3/4" OR	vedi cap. 22	5/100

RACCORDI GENERICI IN OTTONE

BRASS FITTINGS



ART. 1552C

Diritto maschio / maschio
cromato
Chrome-plated straight fitting male
connector

CODICE Code	TIPO Size	PREZZO Price €	CONF. Unit/Box
150 0615	1/4" x 1/4"	0,79	10/400
150 0624	3/8" x 1/4"	0,98	10/400
150 0502	3/8" x 3/8"	1,04	10/400
150 0406	1/2" x 3/8"	1,25	10/350
150 0234	1/2" x 1/2"	1,20	10/300
471 0058	24 (19 Fil) x 1/2"	vedi cap. 17	10/200
150 0447	3/4" x 1/2"	1,75	10/200
150 0435	3/4" x 3/4"	1,86	10/200
150 0613	1" x 1/2"	3,08	5/130
150 0555	1" x 3/4"	3,30	5/130
150 0500	1" x 1"	2,99	5/100



ART. 1555

Raccordo diritto tre pezzi con
O-RING
3 pieces straight fitting with
O-RING

CODICE Code	TIPO Size	PREZZO Price €	CONF. Unit/Box
150 0014	1/2" x 1/2"	3,35	5/100
150 0010	3/4" x 3/4"	4,91	5/50
150 0007	1" x 1"	7,98	5/50
150 0039	1"1/4 x 1"1/4	12,92	5/25
150 0023	1"1/2 x 1"1/2	24,70	2/20
150 0020	2" x 2"	43,13	2/10

A richiesta disponibile anche in versione cromata
Chrome-plated version available on request



ART. 1555N

Raccordo diritto tre pezzi
nichelato con O-RING
Nickel-plated 3 pieces straight fitting
with O-RING

CODICE Code	TIPO Size	PREZZO Price €	CONF. Unit/Box
150 0073	1/2" x 1/2"	3,60	5/100
150 0076	3/4" x 3/4"	5,28	5/50
150 0095	1" x 1"	8,58	5/50
150 0227	1"1/4 x 1"1/4	13,90	5/25
150 0251	1"1/2 x 1"1/2	27,18	2/20
150 0337	2" x 2"	47,43	2/10



ART. 1555R

Raccordo diritto tre pezzi con
O-RING e pretenuta sul filetto
maschio
3 pieces straight fitting with
O-RING and pre-sealed male thread

CODICE Code	TIPO Size	PREZZO Price €	CONF. Unit/Box
150 0523	3/4" x 3/4"	6,40	5/50
150 0283	1" x 1"	9,55	5/50
150 0524	1"1/4 x 1"1/4	19,43	5/25



ART. 1555NR

Raccordo diritto tre pezzi
nichelato con O-RING e
pretenuta sul filetto maschio
Nickel-plated 3 pieces straight fitting
with O-RING and pre-sealed male
thread

CODICE Code	TIPO Size	PREZZO Price €	CONF. Unit/Box
150 0589	3/4" x 3/4"	6,82	5/50
150 0552	1" x 1"	10,25	5/50
150 0595	1"1/4 x 1"1/4	21,20	5/25

TENUTA CON O-RING O-RING

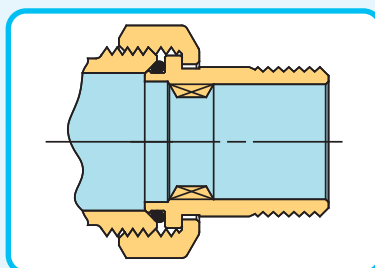

RACCORDI GENERICI IN OTTONE

BRASS FITTINGS



ART. 1555CP

Raccordo diritto tre pezzi con
GUARNIZIONE PIANA
3 pieces straight fitting with **FLAT**
WASHER

CODICE Code	TIPO Size	PREZZO Price €	CONF. Unit/Box
150 0708	3/8" x 3/8"	2,76	10/200
150 0203	1/2" x 1/2"	3,35	5/100
150 0181	3/4" x 3/4"	4,91	5/50
150 0213	1" x 1"	7,98	5/50
150 0320	1"1/4 x 1"1/4	12,92	5/25
150 0575	1"1/2 x 1"1/2	24,70	2/20
150 0556	2" x 2"	43,13	2/10

"CP": TENUTA CON
GUARNIZIONE PIANA
FLAT END WITH FLAT WASHER

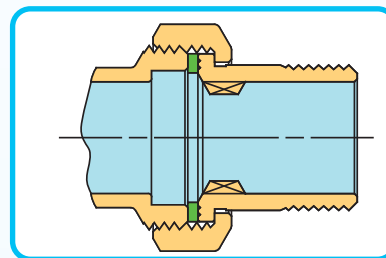

ART. 1557

Raccordo diritto a tre pezzi con
TENUTA CONICA METALLO/
METALLO
3-pieces straight fitting

CODICE Code	TIPO Size	PREZZO Price €	CONF. Unit/Box
150 0186	1/2" x 1/2"	6,70	5/100
150 0199	3/4" x 3/4"	8,08	5/50
150 0177	1" x 1"	13,99	5/50

A richiesta disponibile anche in versione cromata
Chrome-plated version available on request

TENUTA SECCO METALLO/METALLO
BRASS/BRASS SEALING

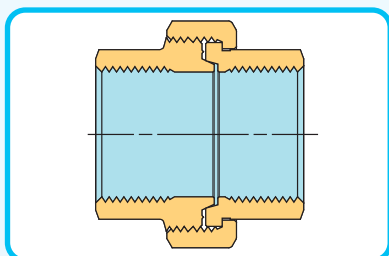

ART. 1557CP

Raccordo diritto a tre pezzi con
GUARNIZIONE PIANA
3-pieces straight fitting with **FLAT**
WASHER

CODICE Code	TIPO Size	PREZZO Price €	CONF. Unit/Box
150 0358	1/2" x 1/2"	6,64	5/100
150 0383	3/4" x 3/4"	7,93	5/50
150 0403	1" x 1"	13,84	5/50



ART. 1557N

Raccordo diritto a tre pezzi
nichelato con **TENUTA CONICA**
METALLO/METALLO
Nickel-plated 3-pieces straight fitting

CODICE Code	TIPO Size	PREZZO Price €	CONF. Unit/Box
150 0374	1/2" x 1/2"	6,91	5/100
150 0368	3/4" x 3/4"	8,59	5/70
150 0206	1" x 1"	14,76	5/50

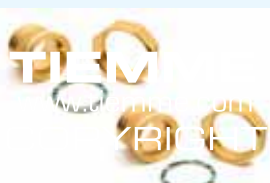

ART. 1555SET

Kit attacco pompa 1"1/2
maschio con sede piana
1"1/2 male pump connection kit
with flat end

CODICE Code	TIPO Size	PREZZO Price €	CONF. Unit/Box
150 0578	1"1/4	18,37	1/20

1555SET

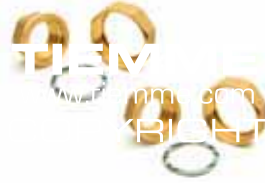
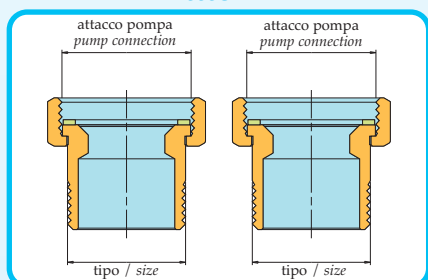

ART. 1557SET

Kit attacco pompa femmina con
sede piana
Female pump connection kit with
flat end

CODICE Code	TIPO Size	ATTACCO POMPA Pump Connection	PREZZO Price €	CONF. Unit/Box
150 0355	1"	1"1/2	16,52	1/20
150 0440	1"1/4	2"	24,49	1/10

1557SET

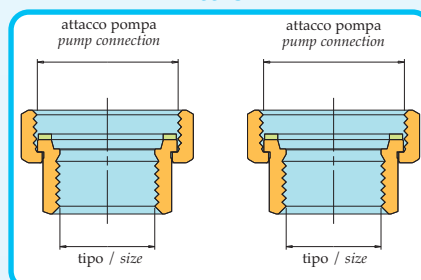

RACCORDI GENERICI IN OTTONE

BRASS FITTINGS



ART. 1560
Curva femmina / femmina
Elbow F/F connector

CODICE Code	TIPO Size	PREZZO Price €	CONF. Unit/Box
150 0298	3/8" x 3/8"	2,40	10/100
150 0508	1/2" x 3/8"	3,49	10/100
150 0018	1/2" x 1/2"	1,90	10/100
150 0149	3/4" x 1/2"	4,30	5/100
150 0015	3/4" x 3/4"	3,24	5/75
150 0111	1" x 3/4"	7,94	5/50
150 0017	1" x 1"	5,61	5/50
150 0340	1"1/4 x 1"	17,49	5/25
150 0067	1"1/4 x 1"1/4	11,67	5/25
150 0117	1"1/2 x 1"1/2	17,95	5/20
150 0121	2" x 2"	23,00	2/10
150 0468	2"1/2 x 2"1/2	43,84	1/5
150 0485	3" x 3"	76,97	1/3
150 0515	4" x 4"	104,92	1/3



ART. 1560N
Curva femmina / femmina
nichelato
Nickel-plated elbow F/F connector

CODICE Code	TIPO Size	PREZZO Price €	CONF. Unit/Box
150 0525	3/8" x 3/8"	2,54	10/200
150 0604	1/2" x 3/8"	3,83	10/150
150 0133	1/2" x 1/2"	2,08	10/180
150 0347	3/4" x 1/2"	4,73	5/100
150 0162	3/4" x 3/4"	3,46	5/80
150 0392	1" x 3/4"	8,77	5/50
150 0144	1" x 1"	6,07	5/50
150 0464	1"1/4 x 1"	19,22	5/35
150 0353	1"1/4 x 1"1/4	12,64	5/35
150 0412	1"1/2 x 1"1/2	19,31	5/20
150 0527	2" x 2"	24,32	2/10
150 0572	2"1/2 x 2"1/2	50,36	1/5
150 0609	3" x 3"	88,54	1
150 0602	4" x 4"	120,58	1



ART. 1560C
Curva femmina / femmina
cromata
Chrome-plated elbow F/F connector

CODICE Code	TIPO Size	PREZZO Price €	CONF. Unit/Box
150 0537	3/8" x 3/8"	2,56	10/200
150 0349	1/2" x 1/2"	2,28	10/180
150 0513	3/4" x 3/4"	3,63	5/80
150 0541	1" x 1"	6,74	5/50
150 0586*	1"1/4 x 1"1/4	14,01	5/35

*disponibile a richiesta / available on request

RACCORDI GENERICI IN OTTONE

BRASS FITTINGS



ART. 1561
Curvo maschio/femmina
Elbow M/F connector

CODICE Code	TIPO Size	PREZZO Price €	CONE. Unit/Box
	A x B		
150 0173	3/8" x 3/8"	2,79	10/100
150 0004	1/2" x 1/2"	2,64	10/100
150 0006	3/4" x 3/4"	3,80	5/50
150 0011	1" x 1"	5,31	5/25
150 0054	1"1/4 x 1"1/4	11,43	5/25
150 0119	1"1/2 x 1"1/2	15,69	5/25
150 0086	2" x 2"	25,53	2/10



ART. 1561N
Curvo maschio/femmina
nichelato
Nickel-plated
elbow M/F
connector

CODICE Code	TIPO Size	PREZZO Price €	CONE. Unit/Box
	A x B		
150 0470	3/8" x 3/8"	3,04	10/200
150 0057	1/2" x 1/2"	2,98	10/150
150 0146	3/4" x 3/4"	4,14	5/60
150 0137	1" x 1"	5,75	5/40
150 0431	1"1/4 x 1"1/4	12,22	5/35
150 0448	1"1/2 x 1"1/2	16,88	5/25
150 0512	2" x 2"	28,07	2/10



ART. 1561DIN
Curvo maschio/femmina serie
pesante
Elbow M/F connector heavy
model

CODICE Code	TIPO Size	PREZZO Price €	CONE. Unit/Box
	A x B		
150 0762	1/2" x 1/2"	3,30	10/100
150 0763	3/4" x 3/4"	4,75	5/50
150 0764	1" x 1"	6,90	5/25



ART. 1561C
Curvo maschio/femmina
cromato
Chrome-plated
elbow M/F
connector

CODICE Code	TIPO Size	PREZZO Price €	CONE. Unit/Box
	A x B		
150 0420	3/8" x 3/8"	3,20	10/200
150 0201	1/2" x 1/2"	3,16	10/150
150 0472	3/4" x 3/4"	4,76	5/60
150 0551	1" x 1"	6,36	5/40

ART. 1561DIN raccordo curvo
maschio/femmina serie pesante (DIN)
ART. 1561DIN elbow male/female connector
heavy model (DIN)

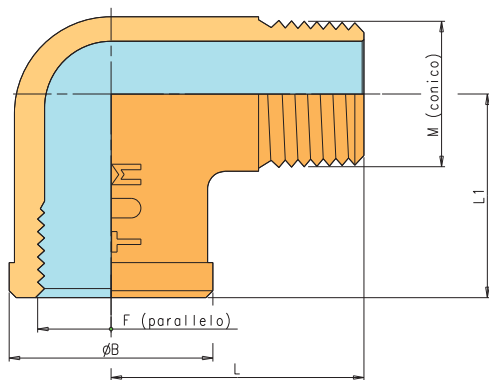

M	F	ART.	CODICE	L	L1	øB
1/2"	1/2"	1561DIN	1500762	36	29	29
3/4"	3/4"	1561DIN	1500763	42	33	35
1"	1"	1561DIN	1500764	54	41	43

ART. 1561 raccordo curvo maschio/femmina
ART. 1561 elbow male/female connector

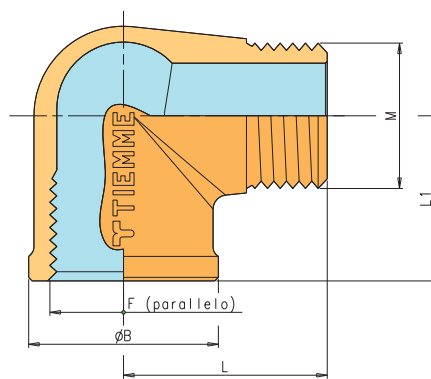

M	F	ART.	CODICE	L	L1	øB
3/8"	3/8"	1561	1500173	32	28,5	23
1/2"	1/2"	1561	1500004	29	23,5	27
3/4"	3/4"	1561	1500006	33,5	26,5	32,5
1"	1"	1561	1500011	39	32	39,5
1"1/4	1"1/4	1561	1500054	44,5	42,5	51
1"1/2	1"1/2	1561	1500119	48,5	47,5	58
2"	2"	1561	1500086	59	55	70

RACCORDI GENERICI IN OTTONE

BRASS FITTINGS



ART. 1562
Curva maschio/maschio
Elbow male/male

CODICE Code	TIPO Size	PREZZO Price €	CONF. Unit/Box
150 0384	3/8" x 3/8"	2,29	10/100
150 0107	1/2" x 1/2"	2,17	10/100
150 0214	3/4" x 3/4"	3,60	10/100



ART. 1562N
Curva maschio/maschio
nichelata
Nickel-plated elbow male/male

CODICE Code	TIPO Size	PREZZO Price €	CONF. Unit/Box
150 0625	3/8" x 3/8"	2,43	10/350
150 0264	1/2" x 1/2"	2,28	10/250
150 0372	3/4" x 3/4"	3,85	10/130



ART. 1563
Curvo maschio/femmina con
flangia
Wallplate elbow M/F

CODICE Code	TIPO Size	PREZZO Price €	CONF. Unit/Box
150 0048	1/2" x 1/2"	2,44	10/100
150 0064	3/4" x 3/4"	4,20	5/50
150 0033	1" x 1"	6,26	5/25



ART. 1563N
Curvo maschio/femmina con
flangia nichelato
Nickel-plated wallplat elbow M/F

CODICE Code	TIPO Size	PREZZO Price €	CONF. Unit/Box
150 0141	1/2" x 1/2"	2,64	10/150
150 0243	3/4" x 3/4"	4,57	5/60
150 0291	1" x 1"	6,78	5/40



ART. 1565
Raccordo curvo tre pezzi con
O-RING
3 pieces elbow with **O-RING**

CODICE Code	TIPO Size	PREZZO Price €	CONF. Unit/Box
150 0410	3/8" x 3/8"	3,98	10/100
150 0105	1/2" x 1/2"	4,11	5/75
150 0063	3/4" x 3/4"	6,48	5/50
150 0068	1" x 1"	11,09	5/25
150 0194	1"1/4 x 1"1/4	19,16	5/20
150 0229	1"1/2 x 1"1/2	31,06	5/10
150 0281	2" x 2"	57,00	2/6



ART. 1565N
Raccordo curvo tre pezzi
nichelato con **O-RING**
Nickel-plated 3 pieces elbow with
O-RING

CODICE Code	TIPO Size	PREZZO Price €	CONF. Unit/Box
150 0510	3/8" x 3/8"	4,37	10/150
150 0168	1/2" x 1/2"	4,41	5/100
150 0244	3/4" x 3/4"	6,96	5/50
150 0250	1" x 1"	11,95	5/30
150 0430	1"1/4 x 1"1/4	20,57	5/20
150 0450	1"1/2 x 1"1/2	34,16	5/10
150 0543	2" x 2"	62,68	2/6



ART. 1565R
Raccordo curvo tre pezzi con
O-RING e pretenuta sul filetto
maschio
3 pieces elbow with **O-RING** and
pre-sealed male thread

CODICE Code	TIPO Size	PREZZO Price €	CONF. Unit/Box
150 0618	3/4" x 3/4"	7,72	5/50
150 0591	1" x 1"	12,31	5/25
150 0620	1"1/4 x 1"1/4	20,40	2/20



ART. 1565NR
Raccordo curvo tre pezzi
nichelato con **O-RING** e
pretenuta sul filetto maschio
Nickel-plated 3 pieces elbow with
O-RING and pre-sealed male thread

CODICE Code	TIPO Size	PREZZO Price €	CONF. Unit/Box
150 0580	3/4" x 3/4"	8,24	5/50
150 0598	1" x 1"	13,24	5/30
150 0583	1"1/4 x 1"1/4	21,90	2/20

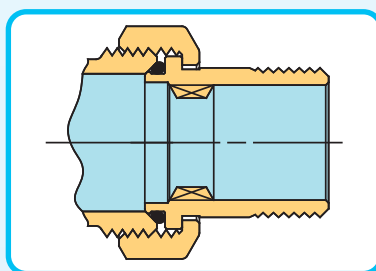

TENUTA CON O-RING
O-RING

RACCORDI GENERICI IN OTTONE

BRASS FITTINGS



ART. 1565CP

Raccordo curvo tre pezzi con
GUARNIZIONE PIANA
3 pieces elbow with **FLAT**
WASHER

"CP": TENUTA CON
GUARNIZIONE PIANA
FLAT END WITH FLAT WASHER

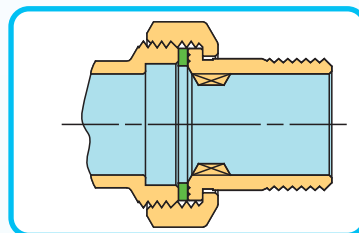

CODICE Code	TIPO Size	PREZZO Price €	CONF. Unit/Box
150 0401	1/2" x 1/2"	4,11	5/75
150 0359	3/4" x 3/4"	6,48	5/50
150 0381	1" x 1"	11,09	5/25
150 0465	1"1/4 x 1"1/4	19,16	5/20
150 0637	1"1/2 x 1"1/2	31,06	5/10
150 0638	2" x 2"	57,00	2/6



ART. 1567

Curvo femmina/femmina con
flangia a 2 fori
Wallplate elbow F/F with 2 holes



ART. 1570N

T femmina nichelato
Nickel-plated tee female connector

CODICE Code	TIPO Size	PREZZO Price €	CONF. Unit/Box
150 0287	1/2" x 1/2"	3,73	10/100
150 0360	3/4" x 3/4"	5,15	5/50

CODICE Code	TIPO Size	PREZZO Price €	CONF. Unit/Box
150 0409	3/8" x 3/8" x 3/8"	3,40	10/150
150 0061	1/2" x 1/2" x 1/2"	2,35	10/110
150 0151	3/4" x 1/2" x 3/4"	4,40	5/70
150 0096	3/4" x 3/4" x 3/4"	3,70	5/50
150 0180	1" x 1/2" x 1"	6,57	5/45
150 0224	1" x 3/4" x 1"	7,13	5/40
150 0083	1" x 1" x 1"	6,34	5/30
150 0331	1"1/4x1"1/4x1"1/4	14,53	5/20
150 0171	1"1/2x1"1/2x1"1/2	18,57	5/15
150 0362	2" x 2" x 2"	27,86	2/10
150 0639	2"1/2x2"1/2x2"1/2	75,32	1
150 0640	3" x 3" x 3"	102,35	1
150 0622	4" x 4" x 4"	148,49	1



ART. 1570

T femmina
Tee female connector



ART. 1570C

T femmina cromato
Chrome-plated tee female connector

CODICE Code	TIPO Size	PREZZO Price €	CONF. Unit/Box
150 0275	3/8" x 3/8" x 3/8"	3,04	10/100
150 0533	1/2" x 3/8" x 1/2"	3,88	10/100
150 0003	1/2" x 1/2" x 1/2"	2,21	10/100
150 0544	3/4" x 3/8" x 3/4"	5,80	5/50
150 0049	3/4" x 1/2" x 3/4"	4,00	5/50
150 0009	3/4" x 3/4" x 3/4"	3,37	5/50
150 0037	1" x 1/2" x 1"	6,25	5/25
150 0087	1" x 3/4" x 1"	6,80	5/25
150 0005	1" x 1" x 1"	6,12	5/25
150 0441	1"1/4 x 1/2" x 1"1/4	16,55	5/25
150 0446	1"1/4 x 3/4" x 1"1/4	16,25	5/25
150 0719	1"1/4 x 1" x 1"1/4	16,73	5/25
150 0029	1"1/4x1"1/4x1"1/4	12,91	5/20
150 0078	1"1/2x1"1/2x1"1/2	16,89	5/15
150 0120	2" x 2" x 2"	25,33	2/10
150 0427	2"1/2x2"1/2x2"1/2	65,52	1/5
150 0428	3" x 3" x 3"	89,02	1/3
150 0481	4" x 4" x 4"	129,15	1/2

CODICE Code	TIPO Size	PREZZO Price €	CONF. Unit/Box
150 0545	3/8" x 3/8" x 3/8"	3,46	10/150
150 0253	1/2" x 1/2" x 1/2"	2,65	10/110
150 0596*	3/4" x 1/2" x 3/4"	4,79	5/70
150 0501	3/4" x 3/4" x 3/4"	4,05	5/50
150 0570	1" x 1" x 1"	7,34	5/30

*disponibile a richiesta / available on request

RACCORDI GENERICI IN OTTONE

BRASS FITTINGS



ART. 1572

T maschio
Tee male connector

CODICE Code	TIPO Size	PREZZO Price €	CONF. Unit/Box
150 0561	3/8" x 3/8" x 3/8"	2,54	10/100
471 0020	1/2" x 1/2" x 1/2"	vedi cap. 22	10/100
150 0225	3/4" x 3/4" x 3/4"	3,78	5/75
150 0216	1" x 1" x 1"	7,88	5/50



ART. 1572FD

Raccordo T filettatura maschio
con sede piana per tubo acciaio
corrugato con guarnizione piana
T fitting male thread with flat seat
for corrugated steel pipe with flat
washer

CODICE Code	TIPO Size	PREZZO Price €	CONF. Unit/Box
471 0020	1/2" x 1/2" x 1/2"	vedi cap. 22	10/100
471 0040	3/4" x 1/2" x 1/2"	vedi cap. 22	5/75
471 0041	3/4" x 1/2" x 3/4"	vedi cap. 22	5/75
471 0060	3/4" x 3/4" x 1/2"	vedi cap. 22	5/75
471 0011	3/4" x 3/4" x 3/4"	vedi cap. 22	5/75
471 0049	1" x 3/4" x 1"	vedi cap. 22	5/50



ART. 1572N

T maschio nichelato
Nickel-plated tee male connector

CODICE Code	TIPO Size	PREZZO Price €	CONF. Unit/Box
150 0619	3/8" x 3/8" x 3/8"	2,64	10/250
150 0233	1/2" x 1/2" x 1/2"	2,98	10/150
150 0334	3/4" x 3/4" x 3/4"	4,07	5/80
150 0391	1" x 1" x 1"	8,66	5/50



ART. 1581

Riduzione maschio/
femmina
Reducing bush
male/female

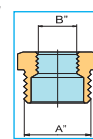

CODICE Code	TIPO Size		PREZZO Price €	CONF. Unit/Box
	A	x B		
150 0455	1/4"	x 1/8"	0,63	25/100
150 0380	3/8"	x 1/8"	0,77	25/100
150 0308	3/8"	x 1/4"	0,58	25/100
150 0506	1/2"	x 1/8"	1,18	25/100
150 0134	1/2"	x 1/4"	0,75	25/100
150 0093	1/2"	x 3/8"	0,67	25/100
150 0209	3/4"	x 3/8"	1,30	10/100
150 0013	3/4"	x 1/2"	0,98	10/100
150 0367	1"	x 1/4"	3,75	10/100
150 0330	1"	x 3/8"	2,73	10/100
150 0030	1"	x 1/2"	2,23	10/100
150 0016	1"	x 3/4"	1,97	10/100
150 0462	1 1/4"	x 1/2"	4,79	5/50
150 0098	1 1/4"	x 3/4"	4,39	5/50
150 0028	1 1/4"	x 1"	3,58	5/50
150 0190	1 1/2"	x 3/4"	7,50	5/50
150 0075	1 1/2"	x 1"	6,26	5/50
150 0082	1 1/2"	x 1 1/4"	5,32	5/50
150 0731	2"	x 1"	12,94	2/40
150 0138	2"	x 1 1/4"	9,80	2/40
150 0130	2"	x 1 1/2"	8,51	2/40
150 0495	2 1/2"	x 1"	38,86	2/30
150 0499	2 1/2"	x 1 1/4"	41,10	2/30
150 0421	2 1/2"	x 1 1/2"	36,69	2/30
150 0219	2 1/2"	x 2"	35,51	2/30
150 0526	3"	x 1 1/2"	58,08	1/15
150 0324	3"	x 2"	54,38	1
150 0398	3"	x 2 1/2"	50,18	1
150 0451	4"	x 2"	70,20	1/10
150 0514	4"	x 2 1/2"	80,46	1/10
150 0518	4"	x 3"	66,78	1/9



ART. 1580

Croce femmina
Cross female connector

CODICE Code	TIPO Size	PREZZO Price €	CONF. Unit/Box
150 0103	1/2"	8,33	5/75
150 0065	3/4"	11,11	5/25
150 0091	1"	19,61	5/25
150 0182	1" 1/4	34,65	5/15
150 0299	1" 1/2	37,44	5/15
150 0414	2"	53,98	1/5

A richiesta disponibile anche in versione cromata
Chrome-plated version available on request



ART. 1580N

Croce femmina nichelato
Nickel-plated cross female connector

CODICE Code	TIPO Size	PREZZO Price €	CONF. Unit/Box
150 0290	1/2"	9,23	5/80
150 0304	3/4"	12,35	5/40
150 0345	1"	21,78	5/30
150 0475	1" 1/4	38,48	5/15
150 0577	1" 1/2	41,63	5/15
150 0557	2"	59,98	1/5

RACCORDI GENERICI IN OTTONE

BRASS FITTINGS



ART. 1581FD

Riduzione maschio/femmina
con sede piana
Reducing bush male/
female with
flat seat

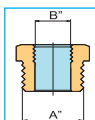

CODICE Code	TIPO Size	PREZZO Price €	CONF. Unit/Box
	A x B		
471 0050	1/2" x 3/8"	vedi cap. 22	25/100
471 0022	3/4" x 1/2"	vedi cap. 22	10/100
471 0079	1" x 1/2"	vedi cap. 22	10/100
471 0012	1" x 3/4"	vedi cap. 22	10/100
471 0038	1" 1/4 x 1"	vedi cap. 22	5/50
471 0043	1" 1/2 x 1" 1/4	vedi cap. 22	5/50

ART. 1581N

Riduzione maschio/femmina
nichelato
Nickel-plated
reducing bush
male/female

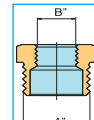

CODICE Code	TIPO Size	PREZZO Price €	CONF. Unit/Box
	A x B		
150 0562	1/4" x 1/8"	0,90	25/1300
150 0569	3/8" x 1/8"	1,12	25/1000
150 0530	3/8" x 1/4"	0,85	25/1000
150 0565	1/2" x 1/8"	2,01	25/500
150 0265	1/2" x 1/4"	1,31	25/500
150 0296	1/2" x 3/8"	0,77	25/500
150 0433	3/4" x 3/8"	1,46	10/250
150 0148	3/4" x 1/2"	1,10	10/250
150 0535	1" x 1/4"	4,16	10/200
150 0503	1" x 3/8"	3,27	10/200
150 0175	1" x 1/2"	2,40	10/180
150 0169	1" x 3/4"	2,11	10/180
150 0352	1" 1/4 x 3/4"	5,27	5/50
150 0238	1" 1/4 x 1"	3,96	5/50
150 0351	1" 1/2 x 3/4"	7,96	5/70
150 0297	1" 1/2 x 1"	6,49	5/70
150 0316	1" 1/2 x 1" 1/4	5,62	5/70
150 0363	2" x 1" 1/4	10,26	2/40
150 0339	2" x 1" 1/2	9,26	2/40
150 0627	2" 1/2 x 2"	40,86	1/30

ART. 1581C

Riduzione maschio/femmina
cromata
Chrome-plated
reducing bush
male/female

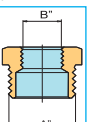

CODICE Code	TIPO Size	PREZZO Price €	CONF. Unit/Box
	A x B		
150 0579	1/4" x 1/8"	1,00	25/1300
150 0588	3/8" x 1/8"	1,24	25/1000
150 0546	3/8" x 1/4"	0,97	25/1000
150 0585	1/2" x 1/8"	2,21	25/500
150 0553	1/2" x 1/4"	1,44	25/500
150 0262	1/2" x 3/8"	1,06	10/500
150 0601	3/4" x 3/8"	1,68	10/250
150 0400	3/4" x 1/2"	1,32	10/250
150 0558	1" x 1/2"	2,68	10/180
150 0539	1" x 3/4"	2,38	10/180
150 0564*	1" 1/4 x 1"	4,35	5/50
150 0611*	1" 1/2 x 1" 1/4	5,76	5/70

*disponibile a richiesta / available on request

ART. 1582

Anello filettato
maschio/femmina
Threaded ring M/F

CODICE Code	TIPO Size	PREZZO Price €	CONF. Unit/Box
150 0445	1/2" x 3/8"	0,68	25/100
150 0356	3/4" x 1/2"	1,02	25/100
150 0357	1" x 3/4"	1,47	10/100

ART. 1583

Ghiera
Brass ring nut

CODICE Code	TIPO Size	PREZZO Price €	CONF. Unit/Box
150 0125	1/2"	0,99	10/100
150 0191	3/4"	1,21	10/100
150 0261	1"	1,55	10/100
150 0310	1" 1/4	1,93	10/100
150 0303	1" 1/2	2,54	5/100
150 0332	2"	5,34	5/100

RACCORDI GENERICI IN OTTONE - STEEL BLOCK

BRASS FITTINGS



ART. 1878
Tappo maschio
Male cap

CODICE Code	TIPO Size	PREZZO Price €	CONF. Unit/Box
150 0273	3/8"	0,56	25/100
150 0040	1/2"	0,65	25/100
150 0019	3/4"	1,17	10/100
150 0077	1"	2,33	10/100
150 0222	1"1/4	4,79	5/100



ART. 1878N
Tappo maschio nichelato
Nickel-plated male cap

CODICE Code	TIPO Size	PREZZO Price €	CONF. Unit/Box
150 0532	3/8"	0,63	25/1000
150 0172	1/2"	0,72	25/600
150 0230	3/4"	1,27	10/300
150 0266	1"	2,40	10/180
150 0488	1"1/4	4,94	5/100



ART. 1880
Tappo femmina
Female cap

CODICE Code	TIPO Size	PREZZO Price €	CONF. Unit/Box
150 0342	3/8"	0,70	25/100
150 0058	1/2"	0,64	25/100
150 0041	3/4"	1,07	10/100
150 0108	1"	2,07	10/100
150 0285	1"1/4	5,71	5/100
150 0327	1"1/2	9,14	5/75
150 0751	2"	16,21	5/50



ART. 1880N
Tappo femmina nichelato
Nickel-plated female cap

CODICE Code	TIPO Size	PREZZO Price €	CONF. Unit/Box
150 0517	3/8"	0,78	25/800
150 0200	1/2"	0,72	25/600
150 0197	3/4"	1,16	10/300
150 0247	1"	2,23	10/200
150 0489	1"1/4	5,95	5/120
150 0755	2"	17,08	2/50

STEEL BLOCK



ART. 1590
Raccordo diritto maschio
Straight fitting male

CODICE Code	TIPO Size	PREZZO Price €	CONF. Unit/Box
150 0118	3/8"	7,53	5/120
150 0021	1/2"	7,41	2/60
150 0051	3/4"	8,80	2/50
150 0056	1"	17,71	2/34
150 0092	1"1/4	28,04	1/20
150 0090	1"1/2	34,24	1/15
150 0085	2"	52,65	1/10



ART. 1591
Raccordo diritto doppio
Straight fitting double

CODICE Code	TIPO Size	PREZZO Price €	CONF. Unit/Box
150 0389	3/8"	8,05	5/80
150 0242	1/2"	10,19	2/50
150 0237	3/4"	14,61	2/40
150 0226	1"	18,37	2/26
150 0282	1"1/4	31,87	1/15
150 0210	1"1/2	39,08	1/15
150 0195	2"	62,99	1/10



ART. 1592
Raccordo diritto femmina
Straight fitting female

CODICE Code	TIPO Size	PREZZO Price €	CONF. Unit/Box
150 0114	3/8"	9,12	5/120
150 0027	1/2"	9,09	2/60
150 0050	3/4"	12,15	2/50
150 0066	1"	17,31	2/34
150 0109	1"1/4	28,80	1/20
150 0099	1"1/2	36,75	1/15
150 0102	2"	56,88	1/10

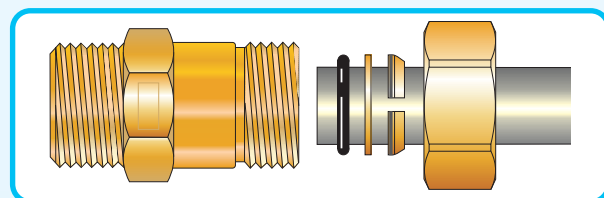
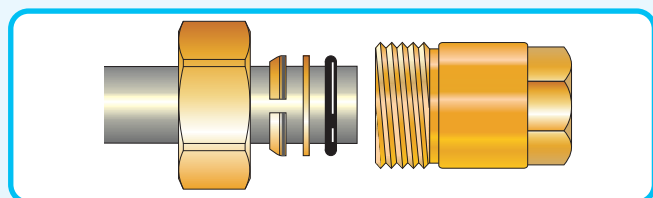
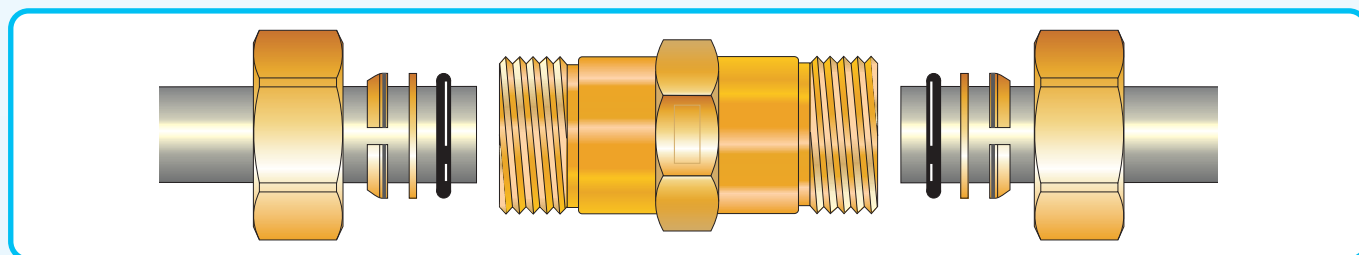

I Raccordi Art. 1590 - 1591 - 1592 sono particolarmente adatti per la riparazione semplice, affidabile e veloce dei tubi in acciaio; non richiedono alcun tipo di filettatura e sono di tipo scorrevole. Questi raccordi utilizzano l'ogiva tagliata conica e vengono forniti con rondella in ottone e O-ring in gomma nitrilica (NBR). Sono pertanto idonei per utilizzo con acqua calda e fredda per uso civile, metano, gpl, gasolio, kerosene, alcoli, glicoli, e grassi vegetali o animali. Non sono idonei per utilizzo con acidi e basi forti, aldeidi, chetoni, ammine, esteri, idrocarburi aromatici, fluidi freno, solventi alogenati, vapore ed ozono.

Intervallo di temperatura di esercizio: -25 + +100°C

Intervallo massima pressione di esercizio: 20 bar

Fittings Art. 1590-1591-1592 are suitable for an easy, fast, and safe maintenance of steel pipes. Do not require any threads and can slide on the pipes. These fittings are supplied with conical ring, brass washer and nitrile rubber O-ring (NBR). They are suitable for use with mineral oil and grease, hydraulic fluids (petro based), aliphatic water up to 100°C. Do not use with concentrated acids and alkalis, ketones, aldehydes, esters, amines, aromatic and halogenated hydrocarbons, brake fluids, steam, ozone.

Working temperature range: -25 + +100°C

Maximum working pressure: 20 bar



ART. 1502

Raccordo diritto per pompa
3 pieces straight fitting with hose connection

CODICE Code	TIPO Size	PREZZO Price €	CONF. Unit/Box
150 0388	15 x 1/2"	6,35	1/40
150 0323	20 x 3/4"	10,56	1/24
150 0329	25 x 1"	13,11	1/30
150 0407	30 x 1"	15,35	1/20
150 0466	30 x 1"1/4	18,96	1/15
150 0452	35 x 1"1/4	20,65	1/15
150 0394	40 x 1"1/2	22,77	1/12
150 0370	50 x 2"	38,29	1/5
150 0424	60 x 2"	88,52	1/6
150 0587	60 x 2"1/2	91,29	1/3



ART. 1503

Raccordo curvo per pompa
3 pieces elbow with hose connection

CODICE Code	TIPO Size	PREZZO Price €	CONF. Unit/Box
150 0490	15 x 1/2"	8,56	1/40
150 0494	20 x 3/4"	13,00	1/20
150 0492	25 x 1"	16,17	1/20
150 0548	30 x 1"	18,74	1/15
150 0600	30 x 1"1/4	23,39	1/15
150 0593	35 x 1"1/4	25,34	1/10
150 0554	40 x 1"1/2	28,84	1/8
150 0538	50 x 2"	53,19	1/4
150 0610	60 x 2"	90,44	1/2
150 0630	60 x 2"1/2	93,63	1/2



ART. 1504

Raccordo tre pezzi per pompa
3 pieces double hose connection

CODICE Code	TIPO Size	PREZZO Price €	CONF. Unit/Box
150 0559	13	6,10	1/50
150 0531	15	6,62	1/40
150 0509	18	6,90	1/40
150 0467	20	10,90	1/24
150 0438	25	13,83	1/30
150 0549	30	15,96	1/20
150 0567	35	18,07	1/10
150 0590	40	24,50	1/8
150 0605	45	31,91	1/5
150 0540	50	36,17	1/5



ART. 1515

Raccordo per cassone diritto
prolungato (fuso)
Straight connector for reservoir
(casted)

CODICE Code	TIPO Size	PREZZO Price €	CONF. Unit/Box
150 0379	1/2"	6,10	1/40
150 0336	3/4"	7,97	1/25
150 0277	1"	10,68	1/15



ART. 1516

Raccordo per cassone diritto
prolungato (stampato)
Straight connector for reservoir
(forged)

CODICE Code	TIPO Size	PREZZO Price €	CONF. Unit/Box
150 0483	3/8"	6,56	1/40
150 0270	1/2"	6,78	1/40
150 0220	3/4"	8,99	1/25
150 0166	1"	12,20	1/15
150 0208	1"1/4	20,02	1/10
150 0295	1"1/2	24,35	1/8
150 0248	2"	38,63	1/5



ART. 1517

Raccordo per cassone con piletta
Connector for reservoir with waste

CODICE Code	TIPO Size	PREZZO Price €	CONF. Unit/Box
150 0469	1/2"	7,51	1/50
150 0411	3/4"	8,66	1/30
150 0371	1"	11,49	1/24
150 0443	1"1/4	17,35	1/10



ART. 1518

Raccordo per cassone con tappo
(Art. 1519 senza tappo)
Connector for reservoir with cap
(Art. 1519 without cap)

CODICE Code	TIPO Size	PREZZO Price €	CONF. Unit/Box
150 0408	1/2"	6,33	1/50
150 0397	3/4"	7,74	1/30
150 0322	1"	9,37	1/24
150 0457	1"1/4	15,21	1/10
Art. 1519			
150 0153	1/2"	5,64	1/50
150 0179	3/4"	7,01	1/30
150 0176	1"	8,19	1/24
150 0231	1"1/4	14,06	1/10



ART. 1520

Raccordo curvo per cassone
Elbow connector for reservoir

CODICE Code	TIPO Size	PREZZO Price €	CONF. Unit/Box
150 0460	1/2"	10,07	1/24
150 0476	3/4"	12,66	1/20
150 0463	1"	18,03	1/12